

NE-4100 Series User's Manual

Ninth Edition, June 2008

www.moxa.com/product

MOXA®

© 2008 Moxa Inc., all rights reserved.
Reproduction without permission is prohibited.

NE-4100 Series User's Manual

The software described in this manual is furnished under a license agreement and may be used only in accordance with the terms of that agreement.

Copyright Notice

Copyright © 2008 Moxa Inc.
All rights reserved.
Reproduction without permission is prohibited.

Trademarks

MOXA is a registered trademark of Moxa Inc.
All other trademarks or registered marks in this manual belong to their respective manufacturers.

Disclaimer

Information in this document is subject to change without notice and does not represent a commitment on the part of Moxa.

Moxa provides this document “as is,” without warranty of any kind, either expressed or implied, including, but not limited to, its particular purpose. Moxa reserves the right to make improvements and/or changes to this manual, or to the products and/or the programs described in this manual, at any time.

Information provided in this manual is intended to be accurate and reliable. However, Moxa assumes no responsibility for its use, or for any infringements on the rights of third parties that may result from its use.

This product might include unintentional technical or typographical errors. Changes are periodically made to the information herein to correct such errors, and these changes are incorporated into new editions of the publication.

Technical Support Contact Information

www.moxa.com/support

Moxa Americas:

Toll-free: 1-888-669-2872
Tel: +1-714-528-6777
Fax: +1-714-528-6778

Moxa China (Shanghai office):

Toll-free: 800-820-5036
Tel: +86-21-5258-9955
Fax: +86-10-6872-3958

Moxa Europe:

Tel: +49-89-3 70 03 99-0
Fax: +49-89-3 70 03 99-99

Moxa Asia-Pacific:

Tel: +886-2-8919-1230
Fax: +886-2-8919-1231

Table of Contents

Chapter 1	Introduction.....	1-1
	Overview	1-2
	Package Checklist	1-2
	Product Features.....	1-2
	Product Specifications.....	1-3
Chapter 2	Panel Layout and Pin Assignments.....	2-1
	NE-4100T, NE-4100-ST	2-2
	Panel Layout	2-2
	NE-4100-ST LED Indicators	2-2
	Pin Assignments.....	2-3
	Block Diagrams	2-4
	NE-4110S, NE-4110A, NE-4110-ST	2-5
	Panel Layout	2-5
	NE-4110-ST LED Indicators	2-6
	Pin Assignments.....	2-6
	Block Diagrams	2-8
	NE-4120S, NE-4120A, NE-4120-ST	2-9
	Panel Layout	2-9
	NE-4120-ST LED Indicators	2-10
	Pin Assignments.....	2-11
	Block Diagrams	2-12
Chapter 3	Getting Started.....	3-1
	Wiring Precautions	3-2
	Installing the NE-4100T onto the NE-4100-ST.....	3-3
	Installing the NE-4110S, NE-4110A onto the NE-4110-ST	3-3
	Installing the NE-4120S, NE-4120A onto the NE-4120-ST	3-4
	Selecting the Serial Interface.....	3-4
	Circuit Pad for External Connection	3-5
	Connecting the Power	3-5
	Connecting to the Network.....	3-6
	Connecting to a Serial Device	3-6
	Digital I/O Channel Settings	3-6
	Digital Output LED Circuit Design	3-8
Chapter 4	Choosing the Proper Operation Mode.....	4-1
	Overview	4-2
	TCP Server Mode.....	4-2
	TCP Client Mode.....	4-3
	UDP Mode.....	4-3
	Real COM Mode	4-4
Chapter 5	Initial IP Address Configuration.....	5-1
	Static vs. Dynamic IP Address	5-2
	Factory Default IP Address	5-2
	NE-4100 Series Administration Suite	5-2
	ARP.....	5-2
	Telnet Console.....	5-3

	Serial Console (19200, n, 8, 1).....	5-6
Chapter 6	Web Console Configuration	6-1
	Opening Your Browser	6-2
	Web Console Navigation.....	6-3
	Basic Settings	6-3
	Network Settings	6-5
	Serial Settings.....	6-8
	Operating Settings	6-9
	TCP Server Mode	6-9
	Real COM Mode.....	6-12
	TCP Client Mode	6-14
	UDP Mode	6-17
	Accessible IP Settings	6-19
	Auto Warning Settings	6-20
	E-mail and SNMP Trap.....	6-20
	Event Type	6-21
	Digital IO	6-22
	DIO Settings.....	6-22
	DIO Monitor	6-23
	Serial Command Mode.....	6-23
	Change Password	6-23
	Load Factory Defaults	6-24
	Save/Restart.....	6-24
Chapter 7	Network Enabler Administrator.....	7-1
	Overview	7-2
	Installing Network Enabler Administrator	7-2
	Network Enabler Administrator Navigation.....	7-4
	Configuration Functions.....	7-5
	Broadcast Search.....	7-5
	Specify by IP Address.....	7-6
	Locate.....	7-6
	Unlock.....	7-7
	Configure	7-8
	Upgrade Firmware	7-10
	Import and Export Configuration.....	7-11
	Monitor Functions	7-12
	Add and Remove Target	7-12
	Load Configured COM Port.....	7-13
	Settings.....	7-13
	Go and Stop.....	7-15
	Port Monitor Functions	7-16
	COM Mapping Functions.....	7-17
	Add and Remove Target	7-17
	COM Settings.....	7-17
	Enable and Disable.....	7-19
	Apply and Discard Change	7-20
	Import and Export COM Mapping.....	7-20
	IP Address Report Functions	7-20
Chapter 8	Linux and UNIX Configuration	8-1

	Linux Real TTY Drivers	8-2
	Basic Procedures	8-2
	Hardware Setup	8-2
	Installing Linux Real TTY Driver Files	8-2
	Mapping TTY Ports	8-3
	Removing Mapped TTY Ports	8-3
	Removing Linux Driver Files	8-4
	UNIX Fixed TTY Driver	8-4
	Installing the UNIX Driver	8-4
	Configuring the UNIX Driver	8-5
Chapter 9	Serial Command Mode	9-1
	Overview	9-2
	Serial Command Format and Command Set	9-2
	Command Structure	9-2
	Reply Structure	9-3
	OP Codes and Parameters	9-3
	Operation Flow Chart	9-8
	Configuring Trigger Type	9-9
	Network Enabler Administrator	9-9
	Telnet Console	9-11
	Web Console	9-12
	Serial Console	9-12
	Entering Serial Command Mode	9-13
	Trigger Type	9-13
	Serial Port Parameters	9-13
	Comments	9-14
	Exiting Serial Command Mode	9-14
	Determining the Active Mode	9-14
	Serial Command Examples	9-15
	Example 1: Get Model Name Using HW Trigger	9-16
	Example 2: Change IP Address Using HW Trigger	9-16
	Example 3: Get IP Mode Using SW Trigger	9-16
	Example 4: Change TCP Port Number Using SW Trigger	9-17
Appendix A	Well Known Port Numbers	A-1
Appendix B	NECI Library	B-1
Appendix C	Auto IP Report Protocol	C-1
	IP Address Report Structure	C-2
	Hardware and AP ID	C-2
	Example	C-2
Appendix D	DIO Commands	D-1
	Overview	D-1
	C Code Example	D-2
	Read Single DIO	D-2
	Command	D-2
	Response	D-2
	C Code Example	D-3
	Write Single DIO	D-3
	Command	D-3

Response	D-3
C Code Example:	D-4
Read Multiple DIO.....	D-4
Command.....	D-4
Response	D-4
C Code Example:	D-5
Write Multiple DIO	D-5
Command.....	D-5
Response	D-6
C Code Example:	D-7

Appendix E	SNMP Agent with MIB II & RS-232 Like Group	E-1
-------------------	---	------------

The NE-4100 Series embedded device server is a line of compact modules that act as network enablers. NE-4100 Series modules can be installed in or on a serial device to connect it to an Ethernet network, allowing you to gain network access to any electronic device that has a serial port. All NE-4100 Series modules come equipped with built-in TCP/IP protocols for fast integration, saving you time and energy on programming.

The following topics are covered in this chapter:

- Overview**
- Package Checklist**
- Product Features**
- Product Specifications**

Overview

NE-4100 Series modules are a type of embedded device server or network enabler. An NE-4100 Series module may be installed in or attached to a serial device to make it accessible from a network. There are three types of module offered: drop-in (NE-4100T), RJ45 (NE-4110S, NE-4110A), and pin header (NE-4120S, NE-4120A). The last letter of the model number indicates the serial signal supported by the module. T indicates a TTL connector, S indicates an RS-232 connector, and A indicates an RS-422/485 connector. Each module includes 4 digital input/output channels, also known as DIO channels or GPIO channels.

NE-4100 Series modules are very compact—less than half the size of a credit card. At such a small size, they can be installed into almost any serial device. Each NE-4100 Series module also comes with a built-in TCP/IP stack for fast integration. Engineers can spend less time on TCP/IP programming, and focus more on developing other major features, thereby shortening your product's time to market. Modules may be easily configured with a user-friendly Windows utility, web browser, serial console, or Telnet console. In addition, a Windows-based NECI (Network Enabler Configuration Interface) library is available to help you develop your own Windows utilities.

Each module comes with a complete development kit containing an evaluation board, documents, sample code, cables, and accessories.

Package Checklist

- 1 NE-4100 Series module
- 1 NE-4100-ST (the evaluation board)
- NE-4100 Series documentation & software CD
- 1 universal power adaptor
- 2 power cords
- 1 null modem cable
- 1 cross-over Ethernet cable
- Warranty statement
- Quick Installation Guide

NOTE: *Please notify your sales representative if any of the above items is missing or damaged.*

Product Features

All NE-4100 Series modules have the following features:

- 10/100 Mbps auto-sensing Ethernet interface
- Compact size and ready-to-go design (NE-4100T measures 45 × 36 mm, NE-4110/4120 measure 57 × 40 mm)
- Built-in TCP/IP firmware for fast integration
- TCP Server, TCP Client, UDP, Real COM driver operation modes
- Low power consumption (1.5W)
- Multiple user-friendly configuration options
- 4 dedicated digital input/output (DIO) channels for user applications
- Software reset

Product Specifications

	NE-4100T	NE-4110S, NE-4110A	NE-4120S, NE-4120A
System			
CPU	16-bit MCU		
RAM	1 MB		
Flash	2 MB		
LAN			
Ethernet	10/100 Mbps, pin headers	10/100 Mbps, RJ45	10/100 Mbps, pin headers
Protection	built-in transformer with 1.5 KV magnetic isolation		
Serial			
Interface	TTL	RS-232 (NE-4110S) RS-422/485 (NE-4110A)	RS-232 (NE-4120S) RS-422/485 (NE-4120A)
Port Type	pin header	RJ45	pin header
Signals	TTL RS-232: TxD, RxD, RTS, CTS, DTR, DSR, DCD, GND RS-422: TxD+, TxD-, RxD+, RxD-, GND RS-485 (2-wire): Data+, Data-, GND RS-485 (4-wire): TxD+, TxD-, RxD+, RxD-, GND		
Serial Communication Parameters			
Parity	None, Even, Odd, Space, Mark		
Data Bits	5, 6, 7, 8		
Stop Bit	1, 1.5, 2		
Flow Control	RTS/CTS, XON/XOFF		
Transmission Speed	50 bps to 115.2 Kbps for PCB V1.x, 110 bps to 230.4 Kbps for PCB V2.x		
Software Features			
Protocols	ICMP, ARP, IP, TCP, UDP, DHCP, HTTP, SNMP, SMTP		
Operating Mode	TCP Server, TCP Client, UDP, Real COM mode		
Utilities	NE utility for Windows 95/98/ME/NT/2000/XP/2003(x64)/XP(x64)		
Configuration	web browser, serial console, Telnet console, or Windows utility		
Power Requirements			
Power Input	5 VDC		
Power Consumption	290 mA @ 5 VDC (Max.)		
Environmental			
Operating Temperature	0°C to 70°C (32°F to 158°F), 5% to 95% RH		
Storage Temperature	-20°C to 85°C (-4°F to 185°F), 5% to 95% RH		
Regulatory Approvals			
EMC	FCC Class A, CE Class A		
Warranty	5 years		

Panel Layout and Pin Assignments

This chapter includes information about the panel layouts and pin assignments for NE-4100 Series modules. The layouts and reference circuit diagrams for the evaluation boards are also covered. The evaluation boards are used for evaluation and development of applications for NE-4100 Series modules.

The following topics are covered in this chapter:

- ❑ **NE-4100T, NE-4100-ST**
 - Panel Layout
 - NE-4100-ST LED Indicators
 - Pin Assignments
 - Block Diagrams
- ❑ **NE-4110S, NE-4110A, NE-4110-ST**
 - Panel Layout
 - NE-4110-ST LED Indicators
 - Pin Assignments
 - Block Diagrams
- ❑ **NE-4120S, NE-4120A, NE-4120-ST**
 - Panel Layout
 - NE-4120-ST LED Indicators
 - Pin Assignments
 - Block Diagrams

NE-4100T, NE-4100-ST

The NE-4100T is a TTL-to-Ethernet drop-in module. It measures 45 × 36 mm, and has a dual-in-line, 26-pin design, making it easy to integrate with your serial devices. The NE-4100-ST is the evaluation board for testing NE-4100T modules and developing your own applications.

Panel Layout

NE-4100T

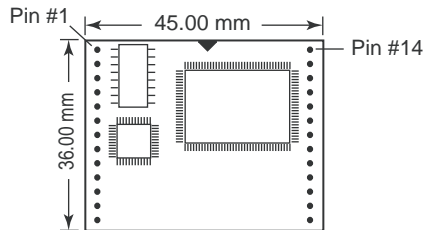

NE-4100-ST

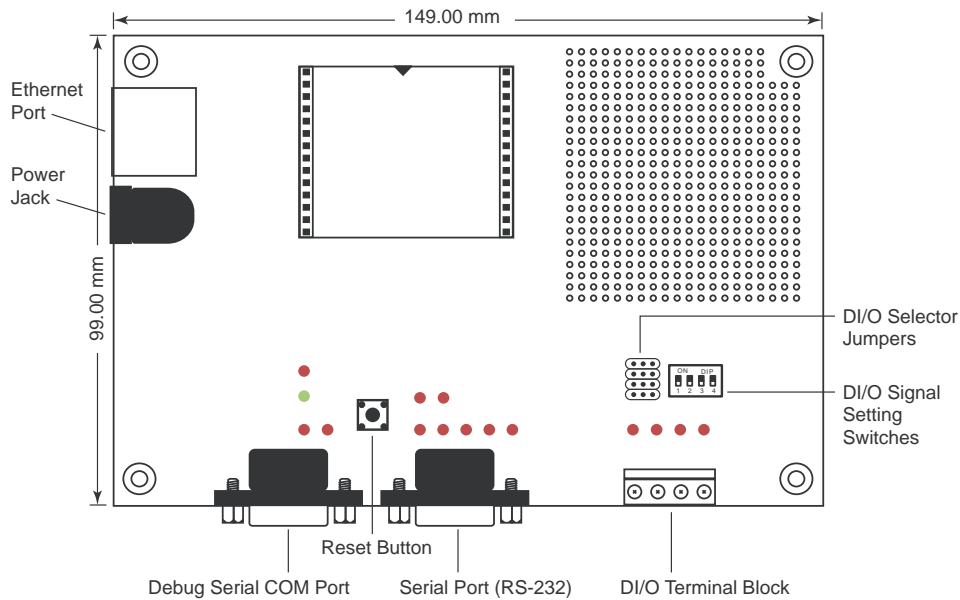

NE-4100-ST LED Indicators

LED Name	LED Color	LED Function
Power	Red	Indicates the power is on.
Ready	Green	Steady on: Power is on and NE-4100T is functioning normally.
		Blinking: NE-4100T has been located by Network Enabler's Administrator's Location function.
	Steady off	<ul style="list-style-type: none"> Power is off, or power error condition exists. IP address cannot be found in DHCP mode. IP address conflict.

LED Name	LED Color	LED Function
DIO0	Red	Indicates that DIO is in "low" (0) status.
DIO1	Red	Indicates that DIO is in "low" (0) status.
DIO2	Red	Indicates that DIO is in "low" (0) status.
DIO3	Red	Indicates that DIO is in "low" (0) status.
TXD0	Red	Indicates that TXD0 has a signal.
RXD0	Red	Indicates that RXD0 has a signal.
DTR0	Red	Indicates that DTR0 has a signal.
CTS0	Red	Indicates that CTS0 has a signal.
DSR0	Red	Indicates that DSR0 has a signal.
DCD0	Red	Indicates that DCD0 has a signal.
RTS0	Red	Indicates that RTS0 has a signal.
TXD1	Red	Indicates that TXD1 has a signal.
RXD1	Red	Indicates that RXD1 has a signal.

Pin Assignments

NE-4100T

Pin	Signal
1	ETx+
2	ETx-
3	ERx+
4	ERx-
5	10M LED
6	TXD
7	RXD
8	RTS
9	CTS
10	Reset
11	GND
12	GND
13	TXD1*

Pin	Signal
14	PIO0
15	PIO1
16	PIO2
17	PIO3
18	100M LED
19	DCD
20	DSR
21	DTR
22	GND
23	Ready LED
24	+5V
25	+5V
26	RXD1*

* Pins 13 and 26 control the NE-4100-ST Debug Serial COM Port's TXD and RXD signals. The location of the Debug Serial COM Port is shown on the previous page. This port is not needed during normal operation. However, if the network fails and you need to configure your NE-4100T, you may connect the Debug Serial COM Port, and then use the serial console to configure your NE-4100T.



ATTENTION

NE-4100T Ethernet Signals: ETx+, ETx-, ERx+, ERx-
 Serial Signals: TXD, RXD, RTS, CTS, DCD, DSR, DTR
 LED Controls: 10M LED, 100M LED, Ready LED

NE-4100-ST Serial Port Pinouts (DB9 Male)

Debug Serial Port for Serial Console		RS-232 Port for Connecting Serial Devices	
Pin	Signal	Pin	Signal
2	RXD	1	DCD
3	TXD	2	RXD
5	GND	3	TXD
		4	DTR
		5	GND
		6	DSR
		7	RTS
		8	CTS

DIO Terminal Block			
D0	D1	D2	D3
⊗	⊗	⊗	⊗

Block Diagrams

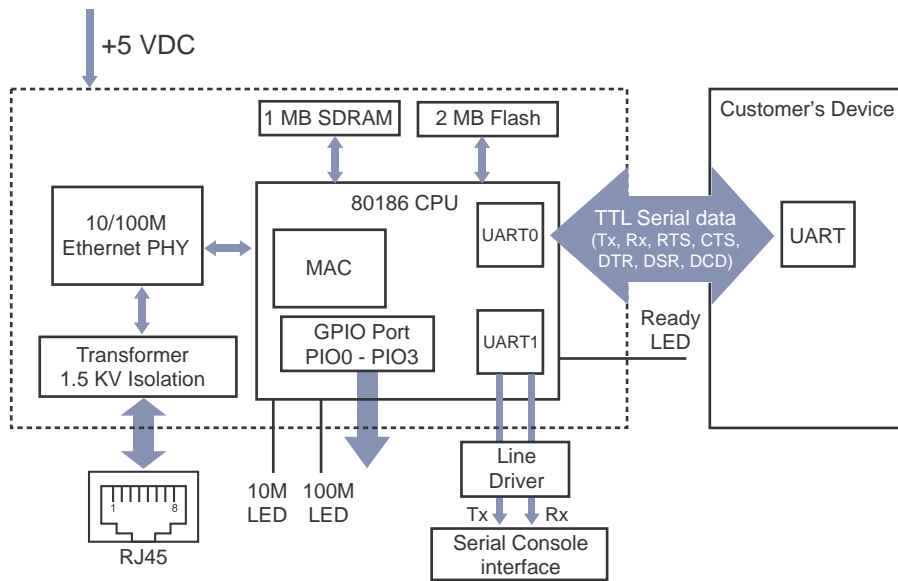

NE-4110S, NE-4110A, NE-4110-ST

The NE-4110S is an RS-232-to-Ethernet server, and the NE-4110A is an RS-422/485-to-Ethernet server. Both models use an RJ45 connection and measure 57 × 40 mm. The NE-4110-ST is the evaluation board for testing NE-4100S and NE-4110A modules and developing your own applications.

Panel Layout

NE-4110S

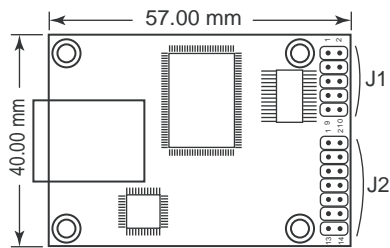

NE-4110A

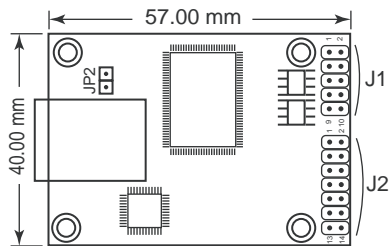

NE-4110-ST

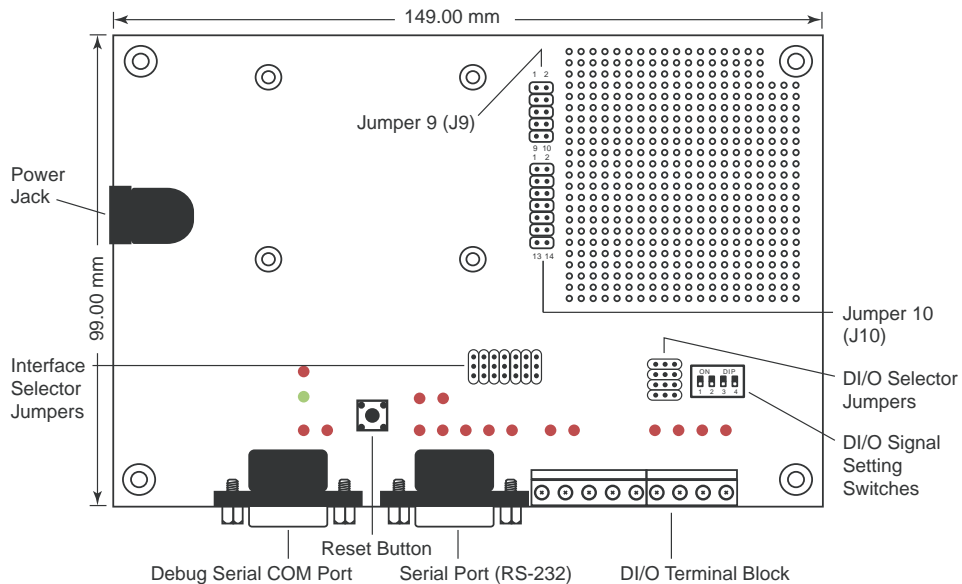

* JP2 is used to select RS-485 (4-wire)/RS-422, or RS-485 (2-wire). Short JP2 to configure it for RS-485 (2-wire), and do not short JP2 to configure it for RS-485 (4-wire)/RS-422.

NE-4110-ST LED Indicators

LED Name	LED Color	LED Function
Power	Red	Indicates the power is on.
Ready	Green	Steady on: Power is on and NE-4110 is functioning normally.
		Blinking: NE-4110 has been located by Network Enabler Administrator.
	Steady off	<ul style="list-style-type: none"> • Power is off, or power error condition exists. • IP address cannot be found in DHCP mode. • IP address conflict.
DIO0	Red	Indicates that DIO is in "low" (0) status.
DIO1	Red	Indicates that DIO is in "low" (0) status.
DIO2	Red	Indicates that DIO is in "low" (0) status.
DIO3	Red	Indicates that DIO is in "low" (0) status.
TXD0	Red	Indicates that TXD0 has a signal.
RXD0	Red	Indicates that RXD0 has a signal.
DTR0	Red	Indicates that DTR0 has a signal.
CTS0	Red	Indicates that CTS0 has a signal.
DSR0	Red	Indicates that DSR0 has a signal.
DCD0	Red	Indicates that DCD0 has a signal.
RTS0	Red	Indicates that RTS0 has a signal.
TXD1	Red	Indicates that TXD1 has a signal.
RXD1	Red	Indicates that RXD1 has a signal.

Pin Assignments

NE-4110S Serial Header Pinouts (J1)

NC	10	9	NC
CTS0	8	7	RTS0
DSR0	6	5	GND
DTR0	4	3	TxD0
RxD0	2	1	DCD0

NE-4110A Serial Header Pinouts (J1)

NC	10	9	NC
NC	8	7	NC
NC	6	5	GND
RxD-	4	3	RxD+
TxD+	2	1	TxD-

**ATTENTION**

The symbols "B" and "A" are often used in place of "+" and "-", respectively.



ATTENTION

For the 2-wire RS-485 interface, pin 3 is for Data+ (B) and pin 4 is for Data- (A).

NE-4110S and NE-4110A Ethernet Port Pinouts

Pin	Signal
1	Tx+
2	Tx-
3	Rx+
6	Rx-

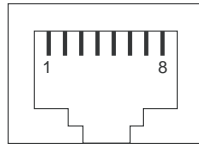

RJ45 Port

NE-4110S and NE-4110A DIO and LED Header Pinouts (J2)

GND	14	13	VCC(+5V)
GND	12	11	VCC(+5V)
DIO0	10	9	10M_LED
DIO1	8	7	100M_LED
DIO2	6	5	Ready_LED
DIO3	4	3	Reset
TxD1	2	1	RxD1

NE-4110-ST Pinouts

Debug Serial Port for Serial Console			RS-232 Port for Serial Devices						
Pin	Signal		Pin	Signal					
2	RXD		1	DCD					
3	TXD		2	RXD					
5	GND		3	TXD					
		4	DTR						
		5	GND						
		6	DSR						
		7	RTS						
		8	CTS						
Serial and DIO Terminal Blocks									
TXD+		TXD-	RXD+	RXD-	SGND	D0	D1	D2	D3

Block Diagrams

NE-4110S Block Diagram

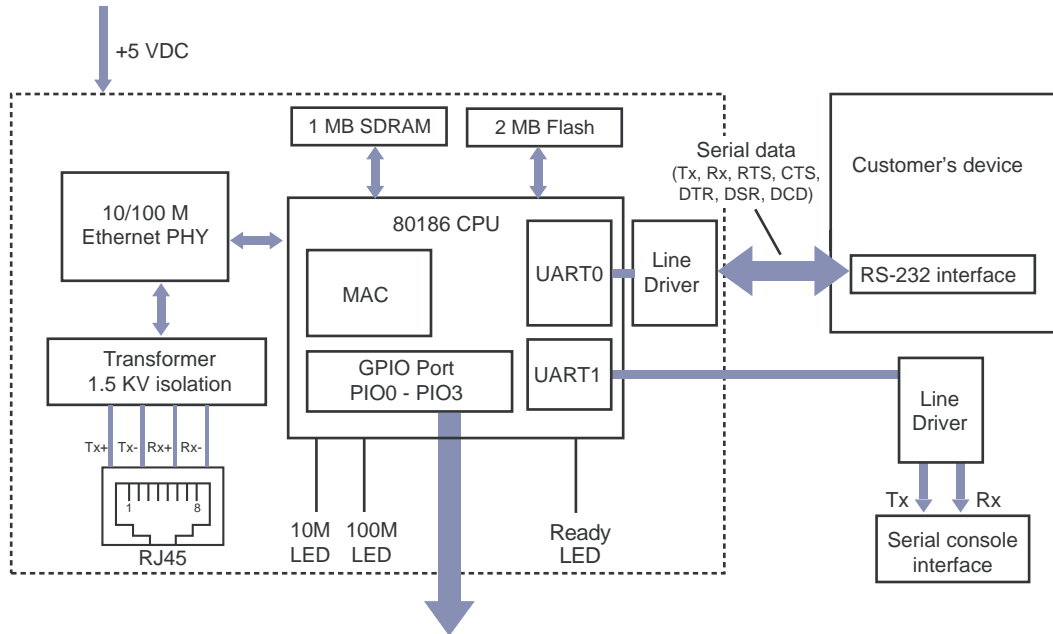

NE-4110A Block Diagram

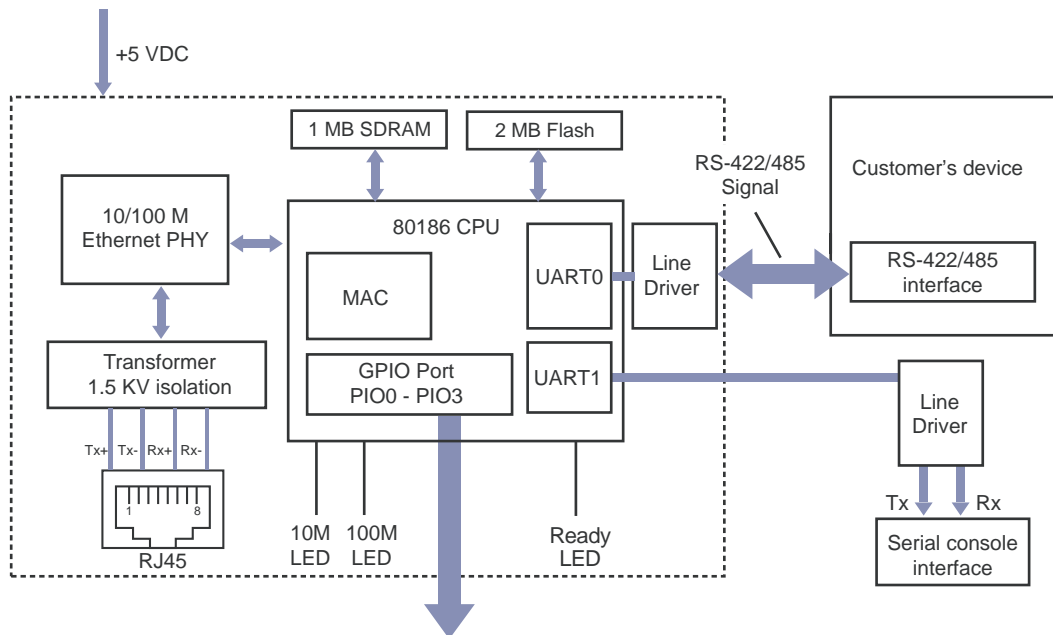

NE-4120S, NE-4120A, NE-4120-ST

The NE-4120S is an RS-232-to-Ethernet server, and the NE-4120A is an RS-422/485-to-Ethernet server. Both models use pin headers instead of RJ45 connectors. The NE-4120-ST is the evaluation board for testing NE-4120S and NE-4120A modules and developing your own applications.



ATTENTION

The NE-4120-ST is the same board as the NE-4110-ST but with an RJ45 jack and pin headers. If your evaluation board has “NE-4110-ST” printed on the board but has the RJ45 jack and pin headers, you have the NE-4120-ST board.

Panel Layout

NE-4120S

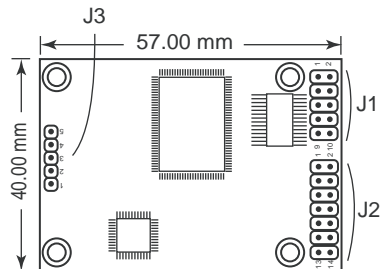

NE-4120A

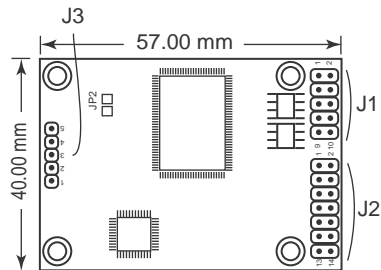

NE-4120-ST

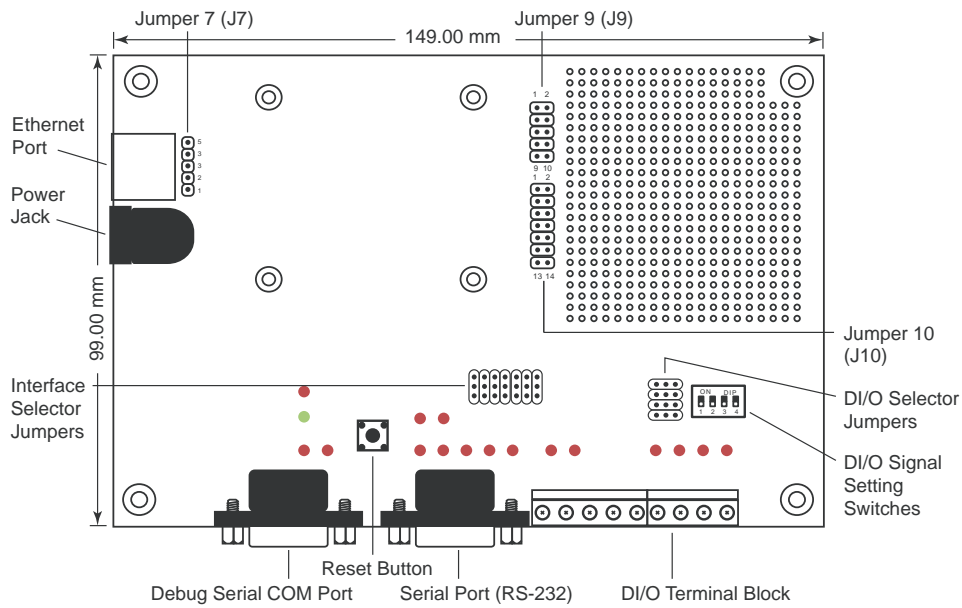

* JP2 is used to select RS-485 (4-wire)/RS-422, or RS-485 (2-wire). Short JP2 to configure it for RS-485 (2-wire), and do not short JP2 to configure it for RS-485 (4-wire)/RS-422.

NE-4120-ST LED Indicators

LED Name	LED Color	LED Function
Power	Red	Indicates the power is on.
Ready	Green	Steady on: Power is on and NE-4120 is functioning normally.
		Blinking: NE-4120 has been located by Network Enabler Administrator.
	Steady off	<ul style="list-style-type: none"> Power is off, or power error condition exists. IP address cannot be found in DHCP mode. IP address conflict.
DIO0	Red	Indicates that DIO is in "low" (0) status.
DIO1	Red	Indicates that DIO is in "low" (0) status.
DIO2	Red	Indicates that DIO is in "low" (0) status.
DIO3	Red	Indicates that DIO is in "low" (0) status.
TXD0	Red	Indicates that TXD0 has a signal.
RXD0	Red	Indicates that RXD0 has a signal.
DTR0	Red	Indicates that DTR0 has a signal.
CTS0	Red	Indicates that CTS0 has a signal.
DSR0	Red	Indicates that DSR0 has a signal.
DCD0	Red	Indicates that DCD0 has a signal.
RTS0	Red	Indicates that RTS0 has a signal.
TXD1	Red	Indicates that TXD1 has a signal.
RXD1	Red	Indicates that RXD1 has a signal.

Pin Assignments

NE-4120S Serial Header Pinouts (J1)

NC	10	9	NC
CTS0	8	7	RTS0
DSR0	6	5	GND
DTR0	4	3	TxD0
RxD0	2	1	DCD0

NE-4120A Serial Header Pinouts (J1)

NC	10	9	NC
NC	8	7	NC
NC	6	5	GND
RxD-	4	3	RxD+
TxD+	2	1	TxD-



ATTENTION

The symbols “B” and “A” are often used in place of “+” and “-”, respectively.



ATTENTION

For the 2-wire RS-485 interface, pin 3 is for Data+ (B) and pin 4 is for Data- (A).

NE-4120S and NE-4120A Ethernet Header Pinouts (J3)

Tx+	1
Tx-	2
	3
Rx+	4
Rx-	5

NE-4120S and NE-4120A DIO and LED Header Pinouts (J2)

GND	14	13	VCC(+5V)
GND	12	11	VCC(+5V)
DIO0	10	9	10M_LED
DIO1	8	7	100M_LED
DIO2	6	5	Ready_LED
DIO3	4	3	Reset
TxD1	2	1	RxD1

NE-4120-ST Pinouts

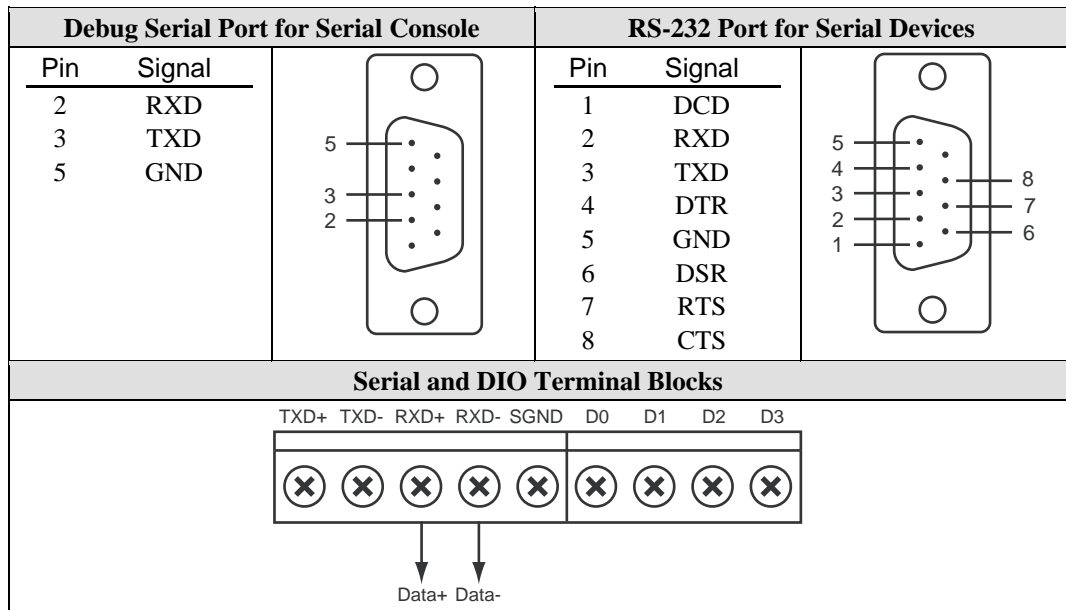

Block Diagrams

NE-4120S Block Diagram

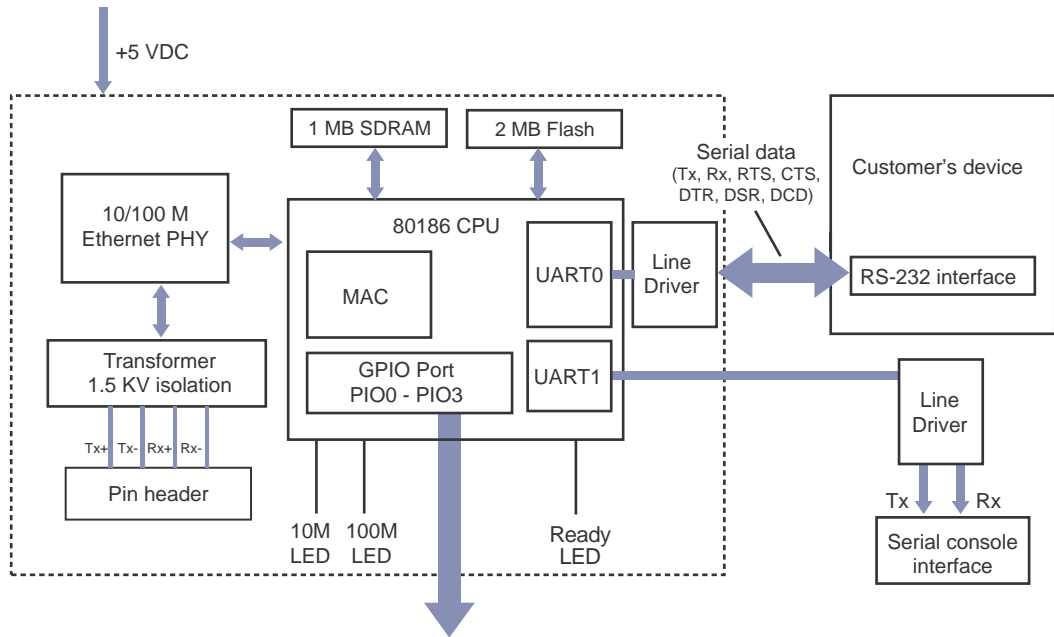

NE-4120A Block Diagram

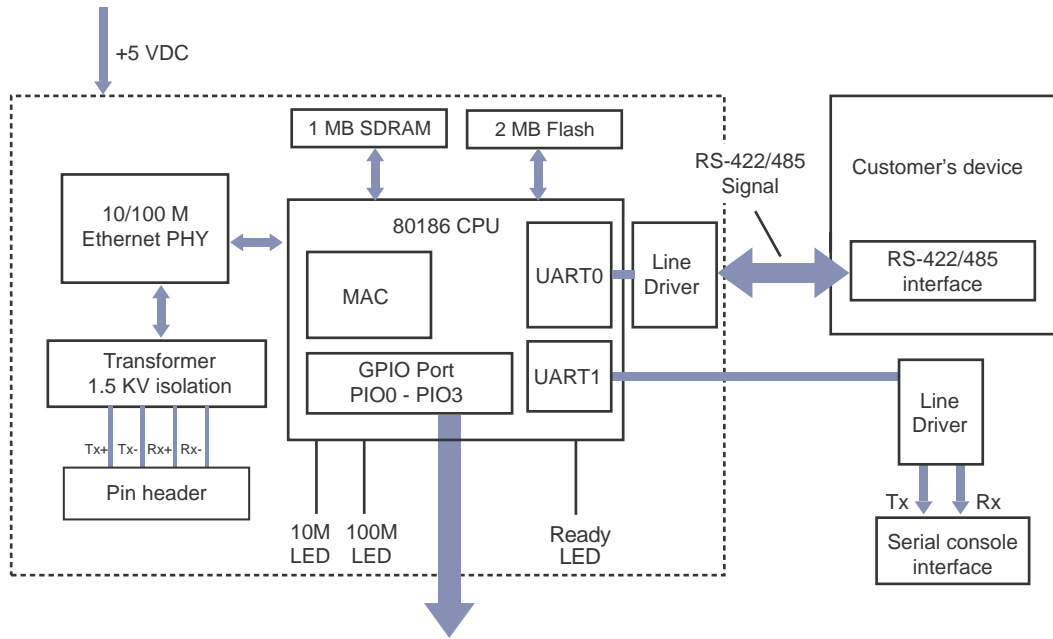

3

Getting Started

This chapter includes information about installation of NE-4100 Series modules for development and testing.

The following topics are covered in this chapter:

- Wiring Precautions**
- Installing the NE-4100T onto the NE-4100-ST**
- Installing the NE-4110S, NE-4110A onto the NE-4110-ST**
- Installing the NE-4120S, NE-4120A onto the NE-4120-ST**
- Selecting the Serial Interface**
- Circuit Pad for External Connection**
- Connecting the Power**
- Connecting to the Network**
- Connecting to a Serial Device**
- Digital I/O Channel Settings**
 - Digital Output LED Circuit Design

Wiring Precautions

This section describes some important safety precautions that you should pay attention to before proceeding with any installation.



ATTENTION

Be sure to disconnect the power cord before installing or wiring the evaluation board.



ATTENTION

Determine the maximum possible current in each power wire and common wire. Observe all electrical codes dictating the maximum current allowable for each wire size.

If the current goes above the maximum ratings, the wiring could overheat, causing serious damage to your equipment.



ATTENTION

Please take care when handling the evaluation boards. When plugged in, the evaluation boards' internal components generate heat, and consequently the board may feel hot to the touch.

You should also pay attention to the following:

- Do not run signal or communication wiring and power wiring in the same wire conduit. To avoid interference, wires with different signal characteristics should be routed separately. Separate paths should be used to route wiring for power and devices. You can use the type of signal transmitted through a wire to determine which wires should be kept separate. The rule of thumb is that wires sharing similar electrical characteristics may be bundled together.
- Keep input wiring and output wiring separate.
- If power wiring and device wiring paths must cross paths, make sure the wires are perpendicular at the intersection point.
- All wiring should be clearly labeled.

Installing the NE-4100T onto the NE-4100-ST

Before using the NE-4100-ST evaluation board with the module, disconnect the power supply, network, and serial device. In the center of the evaluation board, there is a square with one white inverted triangle (shown as black in the figure) on one of its sides, and 2 rows of female sockets on the other two sides. The NE-4100T module also has a white inverted triangle on one of its sides. When attaching the module to the evaluation board, make sure these 2 white inverted triangles are facing the same direction, as shown in the following figure. After the module is installed, connect the power supply, network, and serial device to the evaluation board.

NE-4100-ST Starter Kit

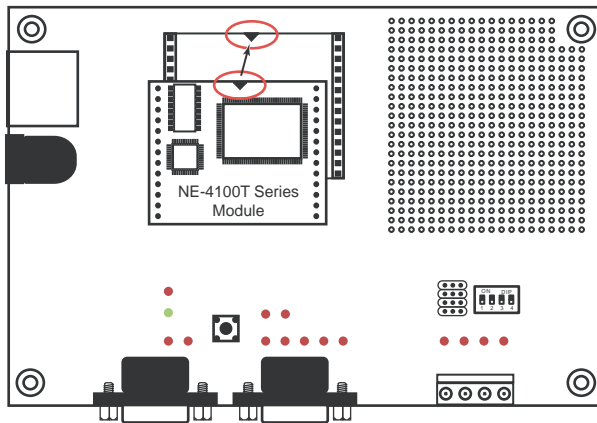

Installing the NE-4110S, NE-4110A onto the NE-4110-ST

The NE-4110S and NE -4110A modules are attached to the NE-4110-ST board using mounting screws that are provided with the board. When attaching the module to the board, make sure that the module is oriented so that the jumper banks on the module and the board are aligned as shown below. Use the provided ribbon cables to connect jumper block J1 on the module to J9 on the board, and jumper block J2 on the module to J10 on the board. When plugging in each ribbon cable, make sure that the red key wire corresponds with pin 1 on each jumper block.

NE-4110-ST Starter Kit

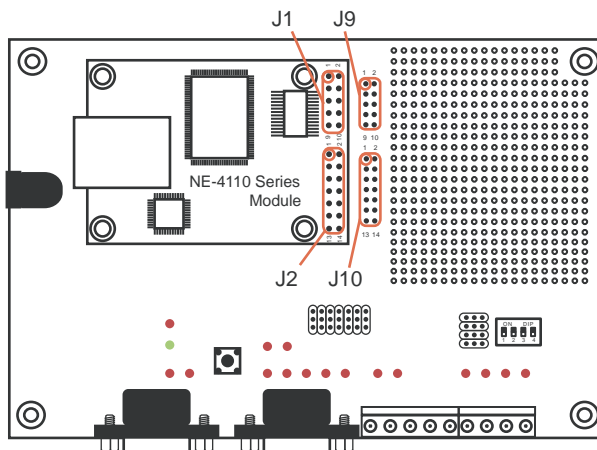

Installing the NE-4120S, NE-4120A onto the NE-4120-ST

The NE-4120S and NE -4120A modules are attached to the NE-4120-ST board using mounting screws that are provided with the board. When attaching the module to the board, make sure that the module is oriented so that the jumper banks on the module and the board are aligned as shown below. Use the provided ribbon cables to connect jumper block J1 on the module to J9 on the board, J2 on the module to J10 on the board, and J3 on the module to J7 on the board. When plugging in each ribbon cable, make sure that the red key wire corresponds with pin 1 on each jumper block.

NE-4120-ST Starter Kit

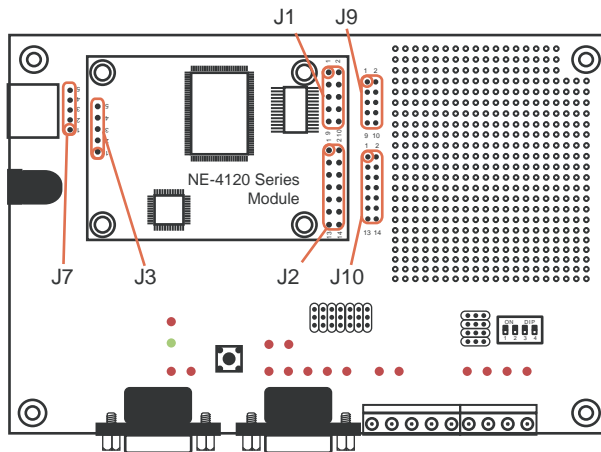

Selecting the Serial Interface

NE-4100 Series modules are available for different serial interfaces. The NE-4110S and NE-4120S are designed for the RS-232 interface, and the NE-4110A and NE-4120A are designed for the RS-422/485 interface. On the NE-4110-ST and NE-4120-ST evaluation boards, the Network Enabler Interface jumper block is used to select the serial interface used for your particular module.

For the NE-4110S and NE-4120S, the evaluation board should be configured for the RS-232 interface, as shown below.

JP2 Network Enabler Interface

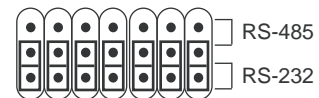

For the NE-4110A and NE-4120A, the evaluation board should be configured for the RS-485 interface, as shown below.

JP2 Network Enabler Interface

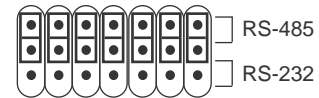

Note that the RS-485 interface is selected on the evaluation board for the NE-4110A and NE-4120A modules, even when the module is operating in RS-422 mode. Please refer to Chapter 2, Panel Layout and Pin Assignments for additional details.

Circuit Pad for External Connection

A circuit pad is provided on the right side of each evaluation board for the development of additional application circuits.

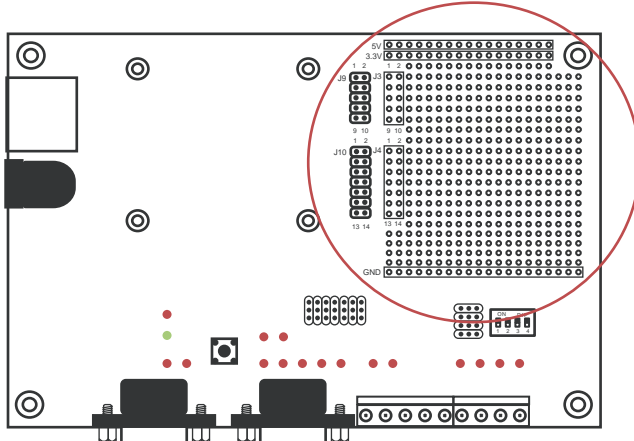

The first row of the circuit pad is for connecting a 5V power supply; the second row is for connecting a 3.3V power supply. The last row of the circuit pad is for grounding. Serial signals are mapped to J3 as an extension of jumper block J9. DIO and LED signals are mapped to J4 as an extension of jumper block J10. This means that pin assignments for J3 on the circuit pad are the same as the pin assignments for jumper block J9; pin assignments for J4 on the circuit pad are the same as the pin assignments for jumper block J10.

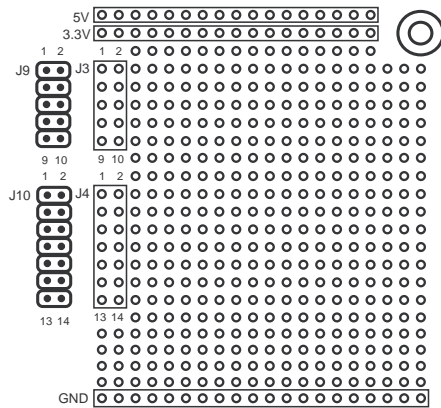

Connecting the Power

Connect the 12 VDC power line with the evaluation board's power jack. If the power is properly supplied, the power LED will show a solid red color until the system is ready, at which time the ready LED will show a solid green color.

Connecting to the Network

To connect to the network for testing and development purposes, the module should be installed onto its evaluation board. Make sure that the module is correctly installed onto the evaluation board, then plug the Ethernet cable into the RJ45 jack. For models NE-4100T, NE-4120S, and NE-4120A, the RJ45 jack is located on the evaluation board; for models NE-4110S and NE-4110A, the RJ45 jack is located on the module itself.

If the cable is properly connected, the RJ45 connector will indicate a valid connection to the Ethernet as follows:



The green LED in the upper right corner blinks when the cable is properly connected to a 100 Mbps Ethernet network, and data is being transmitted.



The yellow LED in the upper left corner blinks when the cable is properly connected to a 10 Mbps Ethernet network, and data is being transmitted.

When using a private IP address for the module, which is the factory default, make sure that netmask and IP settings are configured appropriately in order to access the module from a host on the network.

Connecting to a Serial Device

To connect to a serial device for testing and development purposes, the module should be installed onto its evaluation board. The module's serial signals are routed to and from the RS-232 COM port on the evaluation board. Use a serial data cable to connect the serial device to the COM port on the evaluation board.

Digital I/O Channel Settings

Each module provides 4 digital I/O (DIO) channels. All 4 DIO channels may be configured by software for either digital output or digital input mode. A DI channel is a channel that is operating in digital input mode; a DO channel is a channel that is operating in digital output mode. You may use the evaluation board's Digital Output LEDs and Digital Input DIP switches as the digital input and output devices, or you may connect digital input/output devices to the DI/O Terminal Block.



ATTENTION

When using a digital input device connected to the DI/O Terminal Block, the corresponding Digital Input DIP switch must be set to "OFF" or "High". Setting the DIP switch to "ON" or "Low" will interfere with the signal from your digital input device.

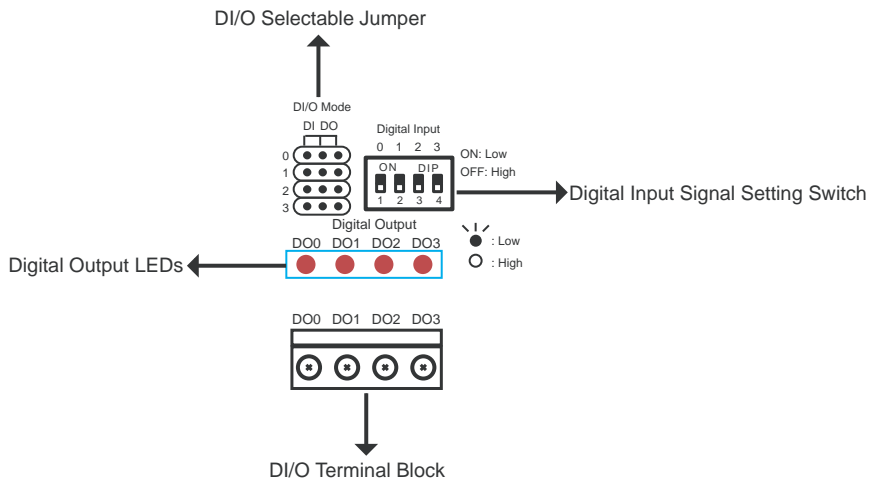

DI/O Mode jumpers 0 through 3 correspond with DIO channels 0 through 3. The jumper's position determines whether the corresponding channel is linked to a DIP switches or to an LED. When a channel's jumper is set to the DI position, the channel's input signal is controlled by the corresponding Digital Input DIP switch. When the jumper is set to the DO position, the channel's output signal is routed to the corresponding Digital Output LED. For example, if DIO channel 0 is operating as a digital input channel, setting DI/O Mode jumper 0 to the DI position enables the use of DIP switch 0 as that channels' input device.

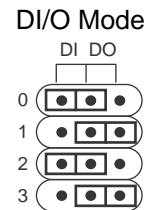

ATTENTION

The DI/O Mode jumpers are used to tell the evaluation board whether to use the Digital Output LEDs or the Digital Input DIP switches. The jumpers do not control the channel's mode. Input and output mode is configured through the web, serial, or Telnet console, or through Network Enabler Administrator.

When using a Digital Input DIP switch as your input device, the "ON" position corresponds to "Low" status and the "OFF" position corresponds to "High" status. The result can be monitored with the Network Enabler Administrator or with the web console. Make sure all DIP switches are set to "OFF" if you are using your own digital input device that is connected to the evaluation board's terminal block.

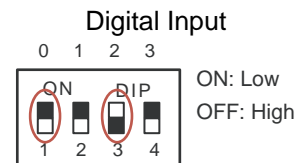

For channels in digital output mode, "Low" and "High" status is controlled from within the web console. When using a Digital Output LED as your output device, "Low" status will be expressed by the LED lighting up, and "High" status will be expressed by the LED turning off.



Digital Output LED Circuit Design

The figure shown below is the digital output LED circuit design. This is known as the “sink” design.



When developing your own applications, you need to be aware of the voltage limits shown below.

		Min.	Max.	Unit	Conditions
Low-level Input Voltage	Maximum voltage when DI is set to “Low” status.	---	0.3xVCC	V	
High-level Input Voltage	Minimum voltage when DI is set to “High” status.	0.7xVCC	---	V	
Low-level Input Voltage	Maximum voltage when DO is set to “Low” status.	---	0.4	V	
High-level Input Voltage	Minimum voltage when DO is set to “High” status	2.4	---	V	

The output current for digital output channels carries only 1 mA.

Choosing the Proper Operation Mode

In this section, we describe the various operation modes of NE-4100 Series modules. Depending on your intended use, the operation mode will determine how serial communication is handled by the network. There is an operation mode for COM port mapping from the host computer as well operation modes for TCP/IP protocols. After choosing the proper operating mode in this chapter, please refer to subsequent chapters for details on configuration parameters.

The following topics are covered in this chapter:

- Overview**
- TCP Server Mode**
- TCP Client Mode**
- UDP Mode**
- Real COM Mode**

Overview

NE-4100 Series modules act as a bridge to connect your serial devices to the Ethernet. The built-in TCP/IP stack means less time spent on programming networking protocols. With one step you may choose the proper operation mode, then use your computer to access, manage, and configure your serial device from anywhere in the world over the Internet.

Traditional SCADA and data collection systems rely on serial ports (RS-232/422/485) to collect data from various kinds of instruments. Since NE-4100 Series modules convert between serial and Ethernet signals, your SCADA and data collection system can be made accessible from every device connected to a standard TCP/IP network, regardless of whether the devices are used locally or at a remote site.

Three different socket modes—TCP Server, TCP Client, and UDP Server/Client—are available, as well as a Real COM mode. The main difference between the TCP and UDP protocol is that TCP guarantees delivery of data by requiring the recipient to send an acknowledgement to the sender. UDP does not require this type of verification, making it possible to offer speedier delivery. UDP also allows multicasting of data to groups of IP addresses.



ATTENTION

The figures in this chapter use the NE-4110S as an example, but they apply to all models in the NE-4100 Series.

TCP Server Mode

In **TCP Server mode**, the module is assigned a unique IP address and port number on the TCP/IP network. The module waits passively to be contacted by the host computer, allowing the host computer to establish a connection with and obtain data from the serial device. This operation mode also supports up to 4 simultaneous connections, so that multiple hosts can collect data from the same serial device—at the same time.

As illustrated in the figure, data transmission proceeds as follows:

1. The host connects to the module configured for TCP Server mode.
2. Once the connection is established, data can be transmitted in both directions—from the host to the module, and from the module to the host.

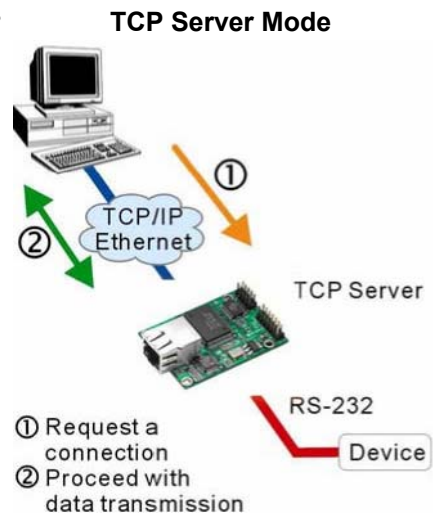

TCP Client Mode

In **TCP Client mode**, the module can actively establish a TCP connection to a pre-defined host computer when serial data arrives.

After the data has been transferred, the module can automatically disconnect from the host computer by using the “TCP alive check time” or “Inactivity time” settings. Please refer to the following chapters for more details.

As illustrated in the figure, data transmission proceeds as follows:

1. The module actively establishes a connection based on the conditions set in the firmware. You may let the module connect to a remote host on startup, or connect later when data from serial device arrives.
2. Once the connection is established, data can be transmitted in both directions—from the host to the module, and from the module to the host.

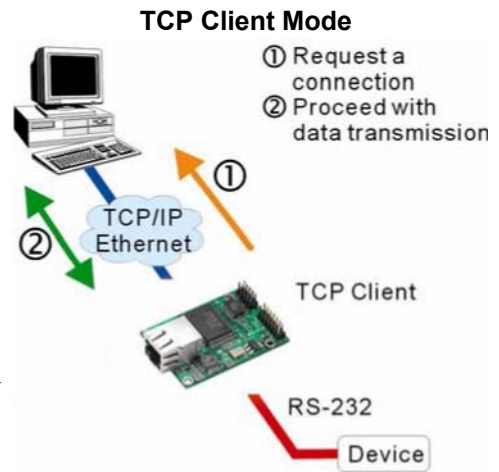

UDP Mode

UDP mode is faster and more efficient than TCP modes. In UDP mode, you can multicast data from the serial device to multiple host computers, and the serial device can also receive data from multiple host computers, making this mode ideal for message display applications.

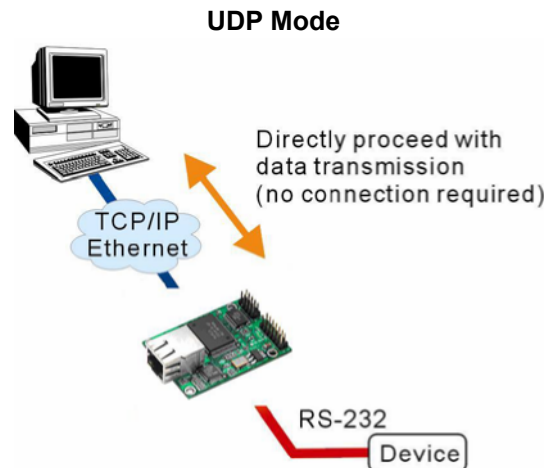

Real COM Mode

Real COM mode allows users to continue using software that was written for pure serial communications applications. Each module comes equipped with COM drivers for Windows systems (95 and above). The serial module's serial port is mapped by the driver to an IP address and port number. The driver intercepts data sent to the host's COM port, packs it into a TCP/IP packet, and then redirects it through the host's Ethernet card. At the other end of the connection, the module accepts the Ethernet frame, unpacks the TCP/IP packet, and then transparently sends the data to the attached serial device. The driver thus establishes a transparent connection between the host and serial device, allowing the host to treat the networked device as if it were directly attached.

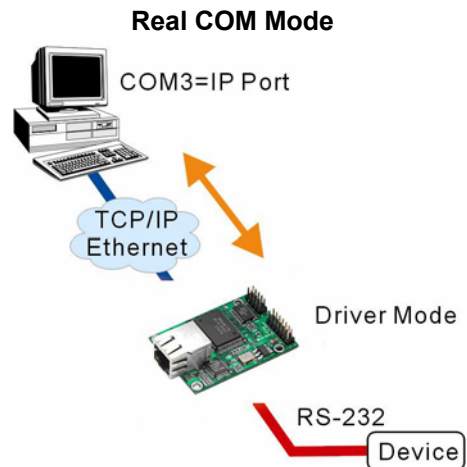

ATTENTION

The Real COM driver comes with Network Enabler Administrator, which is part of the NE-4100 Series Administration Suite.



ATTENTION

Real COM mode can allow several hosts to have simultaneous access to the module. The driver controls host access to attached serial devices by checking the host's IP address against the Accessible IP list.

Use the Accessible IP table to restrict access to the module when a public IP address is required for your application.

5

Initial IP Address Configuration

When setting up your NE-4100 Series module for the first time, the first thing you should do is configure the IP address. This chapter introduces the methods that can be used to configure the module's IP address. For more details about network settings, please refer to the Network Settings section from Chapter 6. Web Console Configuration.

This chapter includes the following sections:

- Static vs. Dynamic IP Address**
- Factory Default IP Address**
- NE-4100 Series Administration Suite** ← *recommended configuration method*
- ARP**
- Telnet Console**
- Serial Console (19200, n, 8, 1)**

Static vs. Dynamic IP Address

Determine whether the module will use a Static IP or Dynamic IP (either DHCP or BOOTP application).

- If the module is used in a Static IP environment, you will configure the IP address directly.
- If the module is used in a Dynamic IP environment, you will configure the module to obtain an IP address dynamically with DHCP, DHCP/BOOTP, or BOOTP.



ATTENTION

Consult your network administrator on how to reserve a fixed IP address for the module in the MAC-IP mapping table when using a DHCP Server or BOOTP Server. For most applications, you should assign a fixed IP address to the module.

Factory Default IP Address

The module is configured with the following default private IP address:

192.168.127.254

Please note that IP addresses of the form 192.168.xxx.xxx are referred to as private IP addresses, since it is not possible to directly access a device configured with a private IP address from a public network. For example, you would not be able to ping such a device from an outside Internet connection. Applications that require sending data over a public network, such as the Internet, require setting up the server with a valid public IP address, which can be leased from a local ISP.

NE-4100 Series Administration Suite

The NE-4100 Series Administration Suite consists of some useful utilities that are used to configure and manage the module. Please refer to Chapter 7 for details on using the NE-4100 Series Administration Suite to set up the module's IP addresses.

ARP

You can use the ARP (Address Resolution Protocol) command to set up the module's IP address. The ARP command tells your computer to associate the module's MAC address with the intended IP address. You must then use Telnet to access the module, at which point the module's IP address will be reconfigured.



ATTENTION

In order to use ARP, both your computer and the module must be connected to the same LAN. You may also use a cross-over Ethernet cable to connect the module directly to your computer's Ethernet port.

Your module must be configured with the factory default IP address before executing the ARP command.

To configure the IP address using ARP, follow these instructions:

1. Obtain a valid IP address for the module from your network administrator.
2. Obtain the module's MAC address from the label on the module.
3. Execute the 'arp -s' command from your computer's MS-DOS prompt by typing:

```
arp -s <new IF address> 00-90-E8-tt-tt-tt
```

For example,

```
arp -s 192.168.200.100 00-90-E8-00-00-00
```

In the example above, 192.168.200.100 is the new IP address and 00-90-E8-00-00-00 is the module's MAC address, as obtained in steps 1 and 2.

4. Execute a special Telnet command by typing:

```
telnet <new IF address> 6000
```

For example,

```
telnet 192.168.200.100 6000
```

After issuing this command, a **Connect failed** message will appear, as shown here. After the module reboots, its IP address will be updated to the new address, and you can reconnect using Telnet, web, or Network Enabler Administrator to verify that the update was successful.



Telnet Console

Depending on how your computer and network are configured, you may find it convenient to use network access to set up your module's IP address. This can be done using the Telnet program, which requires that the module have a network connection and an IP address.

1. From the Windows desktop, click on **Start** and then select **Run**.
2. Telnet to the module's current IP address. If this is the first time configuring the module, you will telnet to the default IP address by typing

```
telnet 192.168.127.254
```

in the **Open** text box, then clicking **OK**.

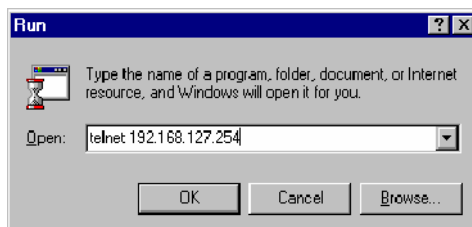

3. Select **Network settings** by pressing **2** and then **Enter**.

```
<< Main Menu >>
(1) Basic setting
(2) Network settings
(3) Serial settings
(4) DIO setting
(5) Operating settings
(6) Accessible IP settings
(7) Auto warning settings
(8) Monitor
(9) Ping
(a) Change password
(b) Load factory default
(v) View settings
(s) Save/Restart
(q) Quit

Key in your selection: 2_
```

4. Select **IP address** by pressing **1** and then **Enter**.

```
<< Main Menu->Network settings >>
(1) IP address
(2) Netmask
(3) Gateway
(4) IP configuration
(5) DNS server 1
(6) DNS server 2
(7) SNMP
(8) SNMP community name
(9) SNMP contact
(a) SNMP location
(b) Auto IP report to IP
(c) Auto IP report to TCP port
(d) Auto IP report period
(v) View settings
(m) Back to main menu
(q) Quit

Key in your selection: 1
```

5. Use the **Backspace** key to erase the current IP address, then type in the new IP address and press **Enter**.

```
<< Main Menu->Network settings >>
(1) IP address
(2) Netmask
(3) Gateway
(4) IP configuration
(5) DNS server 1
(6) DNS server 2
(7) SNMP
(8) SNMP community name
(9) SNMP contact
(a) SNMP location
(b) Auto IP report to IP
(c) Auto IP report to TCP port
(d) Auto IP report period
(v) View settings
(m) Back to main menu
(q) Quit

Key in your selection: 1
IP address: 192.168.127.254
```

6. Press any key to continue.

```
<< Main Menu->Network settings >>
(1) IP address
(2) Netmask
(3) Gateway
(4) IP configuration
(5) DNS server 1
(6) DNS server 2
(7) SNMP
(8) SNMP community name
(9) SNMP contact
(a) SNMP location
(b) Auto IP report to IP
(c) Auto IP report to TCP port
(d) Auto IP report period
(v) View settings
(m) Back to main menu
(q) Quit

Key in your selection: 1
IP address: 192.168.127.254
Set IP address success

Press any key to continue...
```

7. Press **M** and then **Enter** to return to the main menu.

```
<< Main Menu->Network settings >>
(1) IP address
(2) Netmask
(3) Gateway
(4) IP configuration
(5) DNS server 1
(6) DNS server 2
(7) SNMP
(8) SNMP community name
(9) SNMP contact
(a) SNMP location
(b) Auto IP report to IP
(c) Auto IP report to TCP port
(d) Auto IP report period
(v) View settings
(m) Back to main menu
(q) Quit

Key in your selection: m
```

8. Press **S** and then **Enter** to **Save/Restart** the system.

```
<< Main Menu >>
(1) Basic setting
(2) Network settings
(3) Serial settings
(4) DIO setting
(5) Operating settings
(6) Accessible IP settings
(7) Auto warning settings
(8) Monitor
(9) Ping
(a) Change password
(b) Load factory default
(v) View settings
(s) Save/Restart
(q) Quit

Key in your selection: s
```

- Press **Y** and then **Enter** to save the new IP address and restart the module.

```
Ready to restart
(y) Yes
(n) No
Key in your selection: y_
```

Serial Console (19200, n, 8, 1)

If you wish to configure the IP address of the module without going through the network, you may use the serial console, which involves connecting a serial terminal directly to the RS-232 console port on the evaluation board. Moxa offers a free utility called PComm Terminal Emulator that can be used for this purpose, although you are free to choose among other terminal emulators that are widely available. PComm Lite may be downloaded at www.moxa.com.

The following instructions show the procedure using PComm Lite. If you are using another utility, the instructions may vary slightly.

- Plug one end of a serial cable into the RS-232 DEBUG (P1) serial port on the evaluation board; plug the other end directly into your computer's male RS-232 serial port.
- From the Windows desktop, click on **Start** → **Programs** → **PComm Lite** → **Terminal Emulator**.
- When the **PComm Terminal Emulator** window opens, select **Open** from the **Port Manager** menu, or simply click on the **Open** icon.

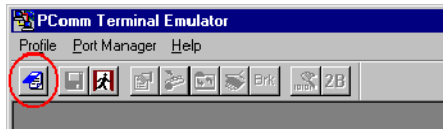

- The **Property** window opens automatically. On the **Communication Parameter** tab, select the appropriate COM port for the connection, COM1 in this example. The parameters should be set to **19200** for Baud Rate, **8** for Data Bits, **None** for Parity, and **1** for Stop Bits.

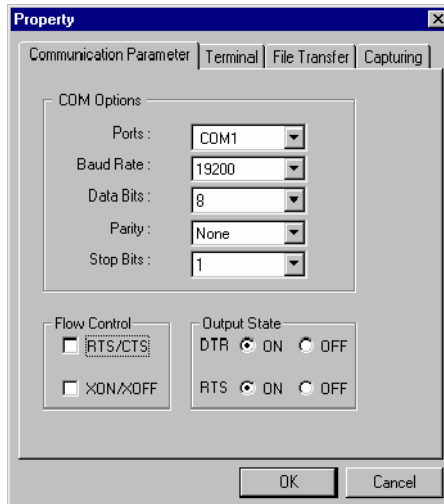

- On the **Terminal** tab, select **ANSI** or **VT100** for **Terminal Type** and then click **OK**.

If you select **Dumb Terminal** as the terminal type, some of the console functions—especially the Monitor function—may not work properly.

- Enter any character to switch automatically from data mode to console mode.

- The serial console will open up. At this point, it will look exactly the same as the Telnet console. Please continue to step 3 in the previous Telnet Console section for the rest of the instructions on setting up the IP address.

```
Model name      : NE-4100T
MAC address     : 00:90:E8:00:00:01
Serial No      : 1
Firmware version : 1.0
-----
<< Main Menu >>
(1) Basic settings
(2) Network settings
(3) Serial settings
(4) DIC setting
(5) Operating settings
(6) Accessible IP settings
(7) Auto warning settings
(8) Monitor
(9) Ping
(a) Change password
(b) Load factory default
(v) View settings
(s) Save/Restart
(q) Quit

Key in your selection:
```

State:OPEN CTS DSR RT DCD Ready

6

Web Console Configuration

The web console is the most user-friendly way to configure your NE-4100 Series module. This chapter introduces the web console function groups and function definitions.

This chapter includes the following sections:

- Opening Your Browser**
- Web Console Navigation**
- Basic Settings**
- Network Settings**
- Serial Settings**
- Operating Settings**
 - TCP Server Mode
 - Real COM Mode
 - TCP Client Mode
 - UDP Mode
- Accessible IP Settings**
- Auto Warning Settings**
 - E-mail and SNMP Trap
 - Event Type
- Digital IO**
 - DIO Settings
 - DIO Monitor
- Serial Command Mode**
- Change Password**
- Load Factory Defaults**
- Save/Restart**

Opening Your Browser

1. Open your browser with the cookie function enabled. (To enable your browser for cookies, right click on your desktop Internet Explorer icon, select Properties, click on the Security tab, and then select the three Enable options as shown in the figure below.)

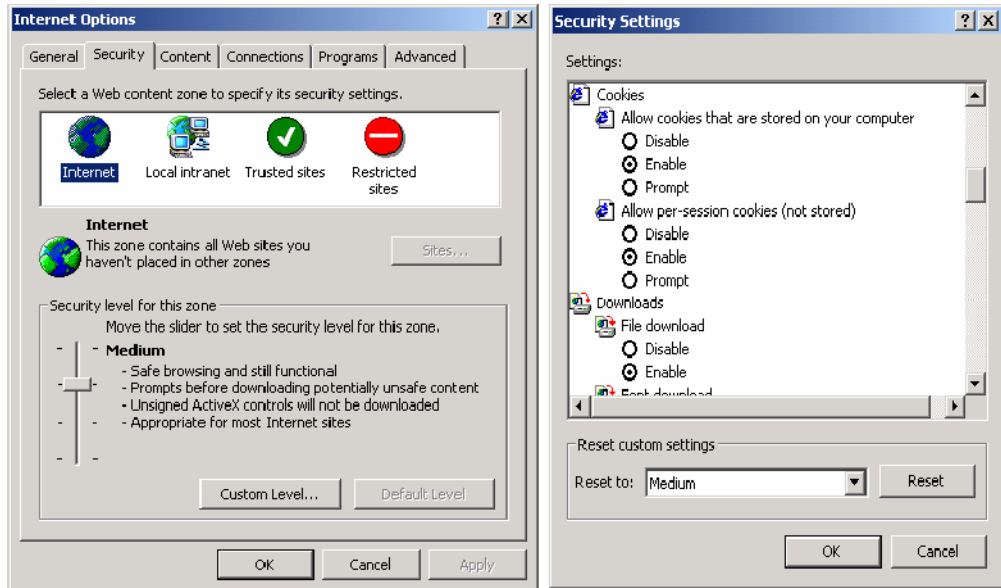

2. Type 192.168.127.254 in the **Address** box (use the correct IP address if different from the default), and then press **Enter**.



ATTENTION

If you use other web browsers, remember to enable the functions to “allow cookies that are stored on your computer” or “allow per-session cookies.”

NE-4100 Series modules only use cookies for password transmission.



ATTENTION

Please refer to Chapter 5, Initial IP Address Configuration for instructions on IP configuration. The examples in this chapter use the factory default IP address (192.168.127.254).

3. The web console will open. On this page, you can see a brief description of the web console's eleven function groups.

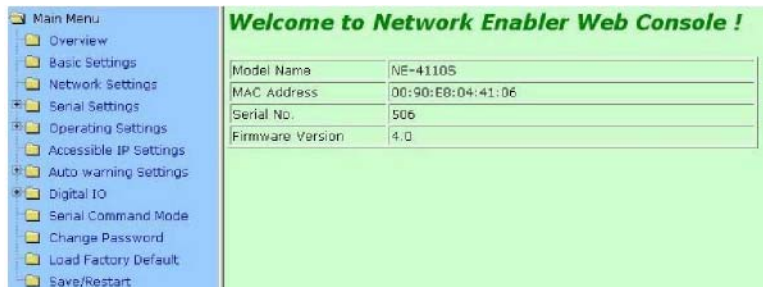

NOTE: “Serial Command Mode” is supported in firmware version 3.0 and above.



ATTENTION

If you forget the password, the **ONLY** way to configure the module is to “load factory defaults.” Remember to use Network Enabler Administrator to export the configuration file when you have finished the configuration. After loading factory defaults, your configuration can be easily reloaded into the module. Please refer to Chapter 7 for more details about exporting and importing configuration settings.

Web Console Navigation

On the web console, the left panel is the navigation panel and contains an expandable menu tree for navigating among the various settings and categories. When you click on a menu item in the navigation panel, the main window will display the corresponding options for that item. Configuration changes can then be made in the main window. For example, if you click on **Basic Settings** in the navigation panel, the main window will show a page of basic settings that you can configure.

You must click on the **Submit** button to keep your configuration changes. The **Submit** button will be located at the bottom of every page that has configurable settings. If you navigate to another page without clicking the **Submit** button, your settings will not be retained.

Changes will not take effect until they are saved and the module is restarted! You may complete this in one step by clicking on **Save/Restart** after you submit a change. If you restart the module without saving your configuration, the module will discard all submitted changes.

Basic Settings

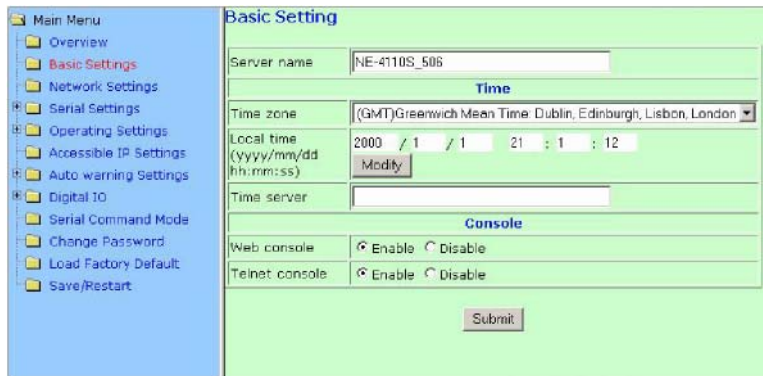

NOTE: “Serial Command Mode” is supported in firmware version 3.0 and above.

Server name

Setting	Factory Default	Necessity
1 to 39 characters	NP[model name]_[Serial No.]	Optional

This option can be used to specify the location or application of the module, which may be useful when managing more than one module on the network.

Time

The module has a built-in Real-Time Clock for time calibration functions. Functions such as Auto warning e-mail or SNMP trap can add real-time information to the message.



ATTENTION

Always select and submit the time zone before modifying the time. The console will display the real time according to the time zone compared to GMT.

If you would like to modify the real time clock, select **Local Time**. The module's firmware will modify the GMT time according to the Time Zone.

Time zone

Setting	Factory Default	Necessity
User selectable time zone	GMT (Greenwich Mean Time)	Optional

Local time

Setting	Factory Default	Necessity
User adjustable time.	GMT (Greenwich Mean Time)	Optional

Click on the **Modify** button to open the **Modify time settings** window to input the correct local time.

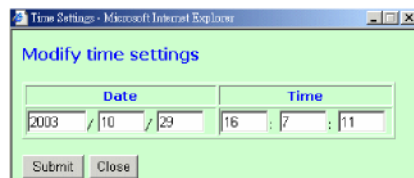

Time server

Setting	Factory Default	Necessity
IP or domain address (E.g., 192.168.1.1, time.stdtime.gov.tw, or time.nist.gov)	None	Optional

NE-4100 Series modules use SNTP (RFC-1769) for auto time calibration.

Enter the Time Server IP address or domain address. When the Time Server IP address is provided, the module will request time information from the Time Server every 10 minutes.

Console

Web console, Telnet console

Setting	Factory Default	Necessity
Enable or Disable	Enable	Required

The web console and Telnet console can be disabled for security reasons. In some cases, you may want to disable one or both of these console utilities as an extra precaution to prevent unauthorized users from accessing the module. The factory default for both web console and Telnet console is Enable.



ATTENTION

If you disable both the web console and Telnet console, you can still use the serial console or Network Enabler Administrator to configure the module.

Network Settings

NOTE: “Serial Command Mode” is supported in firmware version 3.0 and above.

You must assign a valid IP address to the module before it will work in your network environment. Your network system administrator should provide you with an IP address and related settings for your network. The IP address must be unique within the network; otherwise the module will not have a valid connection to the network. First time users can refer to Chapter 5 - Initial IP Address Configuration for more information.

IP configuration

Method	Function Definition
Static	User defined IP address, Netmask, Gateway.
DHCP	DHCP Server assigned IP address, Netmask, Gateway, DNS, and Time Server
DHCP/BOOTP	DHCP Server assigned IP address, Netmask, Gateway, DNS, and Time Server, or BOOTP Server assigned IP address
BOOTP	BOOTP Server assigned IP address

IP configuration is a required field. The default setting is Static.



ATTENTION

In Dynamic IP environments, the module will attempt to obtain an IP address from the DHCP or BOOTP server 3 times at 30-second intervals. The timeout for the first try will be 1 second, the second try will be to 3 seconds, and the last try will be 5 seconds.

If the DHCP/BOOTP Server is unavailable, the module will use the default IP address (192.168.127.254), netmask, and gateway settings.

IP Address

Setting	Factory Default	Necessity
E.g., 192.168.1.1 (IP addresses of the form x.x.x.0 and x.x.x.255 are invalid.)	192.168.127.254	Required

An IP address is a number assigned to a network device, such as a computer, as a permanent address on the network. Computers use the IP address to identify and talk to each other over the network. Choose a proper IP address which is unique and valid in your network environment.

Netmask

Setting	Factory Default	Necessity
E.g., 255.255.255.0	255.255.255.0	Required

A subnet mask represents all the network hosts at one geographic location, in one building, or on the same local area network. When a packet is sent out over the network, the module will use the subnet mask to check whether the host specified in the packet is on a local network segment. If the address is on the same network segment as the module, a connection is established directly from the module. Otherwise, the connection is established through the default gateway.

Gateway

Setting	Factory Default	Necessity
E.g., 192.168.1.1	None	Optional

A gateway acts as an entrance to another network. Usually, the computers that control traffic within the network or at the local Internet service provider are gateway nodes. The module needs to know the IP address of the default gateway computer in order to communicate with the hosts outside the local network environment. For correct gateway IP address information, consult your network administrator.

DNS server 1 / DNS sever 2

Setting	Factory Default	Necessity
E.g., 192.168.1.1 (IP addresses of the form x.x.x.0 and x.x.x.255 are invalid.)	None	Optional

Domain Name System (DNS) is how Internet domain names are identified and translated into IP addresses. A domain name is an alphanumeric name, such as moxa.com, that it is usually easier to remember. A DNS server is a host that translates the text-based domain name into the corresponding numeric IP address which is used to establish a TCP/IP connection. When the user enters a website address, the computer asks a DNS server for the website's IP address to connect to the web server.

When a DNS server is specified, the module acts as DNS client and will allow domain names instead of IP addresses to be used on the web console. The following web console fields support the use of domain names: Time Sever IP Address, TCP Client-Destination IP Address, Mail Server, SNMP Trap IP Address, and IP Location Server. Two DNS servers may be specified, **DNS server 1** and **DNS server 2**. DNS server 2 is included for use when DNS sever 1 is unavailable.

SNMP Settings

Community name

Setting	Factory Default	Necessity
1 to 39 characters (E.g., Support, 886-89191230 #300)	public	Optional

A community name is a plain-text password mechanism that is used to weakly authenticate queries to agents of managed network devices.

Contact

Setting	Factory Default	Necessity
1 to 39 characters (E.g., Support, 886-89191230 #300)	None	Optional

The SNMP contact information usually includes an emergency contact name and telephone or pager number.

Location

Setting	Factory Default	Necessity
1 to 39 characters (E.g., Floor 1, office 2)	None	Optional

Enter a location string for SNMP agents. This string is usually set to the street address where the module is physically located.

IP Address report

When the module is used in a dynamic IP environment, additional time must be spent on IP management tasks. For example, when a module is operating as a server (TCP or UDP modes), a PC operating as a client will need to know the module's IP address. If the DHCP server assigns a new IP address to the module, the PC must have some way of obtaining the module's new IP address. The **IP Address report** fields are used to set up periodic reporting of the module's IP address when the module's IP address is assigned by a server. The IP address report is sent automatically at regular intervals to an IP address and TCP port number of your choice. There are two ways view the module's IP address report on a PC:

- Install Network Enabler Administrator and use the built-in IP Address Report function.
- Develop software that parses the IP address report data. Please refer to Appendix C for details on how to parse the module's IP address report data.

Auto report to IP

Setting	Factory Default	Necessity
E.g., 192.168.1.1 or URL (IP addresses of the form x.x.x.0 and x.x.x.255 are invalid.)	None	Optional

If left blank, auto IP reporting is disabled. If an IP address is entered along with a TCP port number, the IP address reports will be sent to the specified address and port number.

Auto report to TCP port

Setting	Factory Default	Necessity
E.g., 4001	4002	Optional

If left blank, auto IP reporting is disabled. If a TCP port number is entered along with an IP address, the IP address reports will be sent to the specified address and port number.

Auto report period

Setting	Factory Default	Necessity
Time interval (in seconds)	10	Optional

The **Auto report period** field specifies how often the module will report its IP address. An auto report period of 10 seconds means that an IP address report will be sent every 10 seconds.

**ATTENTION**

The module will send IP address reports only when assigned an IP address from a DHCP or BOOTP server. If a connection to a DHCP or BOOTP server is not available, no IP address report will be sent.

Serial Settings

NOTE: “Serial Command Mode” is supported in firmware version 3.0 and above.

Port Alias

Setting	Factory Default	Necessity
1 to 15 characters (E.g., PLC-No.1)	None	Optional

This function is designed for future use. You may enter a string to help in the module's serial port from other serial ports.

Serial Parameters

**ATTENTION**

Refer to the serial communication parameters in your serial device's user's manual. The module's serial parameters should be the same as the parameters used by your serial device.

Baud Rate

Setting	Factory Default	Necessity
50 bps to 115.2 Kbps for PCB V1.x 110 bps to 230.4 Kbps for PCB V2.x	115.2 Kbps	Required

The module can be set for baud rates between 50 bps and 115.2 Kbps for PCB V1.x and between 110 bps to 230.4 Kbps for PCB V2.x.

Data Bits

Setting	Factory Default	Necessity
5, 6, 7, 8	8	Required

When the user sets Data Bits to 5 bits, the Stop Bits setting will automatically change to 1.5 bits.

Stop Bits

Setting	Factory Default	Necessity
1, 2	1	Required

Stop Bits will be set to 1.5 when Data Bits is set to 5 bits.

Parity

Setting	Factory Default	Necessity
None, Even, Odd, Space, Mark	None	Required

Flow control

Setting	Factory Default	Necessity
None, RTS/CTS, DTR/DSR, XON/XOFF	RTS/CTS	Required

FIFO

Setting	Factory Default	Necessity
Enable, Disable	Enable	Required

Each module's serial port provides a 16-byte FIFO both in the Tx and Rx directions. Disable the FIFO setting when your serial device does not have a FIFO to prevent data loss during communication.

Operating Settings

TCP Server Mode

The screenshot shows the 'Operating Settings' page for Port 01. The configuration is as follows:

- Port = 01**
- Operation mode:** TCP Server Mode
- TCP alive check time:** 7 (0 - 99 min)
- Inactivity time:** 0 (0 - 65535 ms)
- Max connection:** 1 (1 - 4)
- Data Packing:**
 - Delimiter 1: 0 (Hex) Enable
 - Delimiter 2: 0 (Hex) Enable
 - Force transmit: 0 (0 - 65535 ms)
- TCP Server Mode:**
 - Local TCP port: 4001
 - Apply the above settings to all serial ports

A 'Submit' button is located at the bottom of the configuration area.

NOTE: "Serial Command Mode" is supported in firmware version 3.0 and above.

TCP alive check time

Setting	Factory Default	Necessity
0 to 99 min	7 min	Optional

0 min: The TCP connection is not closed due to an idle TCP connection.

1 to 99 min: The module automatically closes the TCP connection if there is no TCP activity for the given time. After the connection is closed, the module starts listening for another host's TCP connection.

Inactivity time

Setting	Factory Default	Necessity
0 to 65535 ms	0 ms	Optional

0 ms: The TCP connection is not closed due to an idle serial line.

0-65535 ms: The module automatically closes the TCP connection if there is no serial data activity for the given time. After the connection is closed, the module starts listening for another host's TCP connection.

This parameter defines the maintenance status as Closed or Listen on the TCP connection. The connection is closed if there is no incoming or outgoing data through the serial port during the specific Inactivity time.

If Inactivity time is set to 0, the current TCP connection is maintained until there is a connection close request. Even with Inactivity time is disabled, the module will still check the connection status between itself and the remote host by sending "keep alive" packets periodically. If the remote host does not respond to the packet, it assumes that the connection was closed down unintentionally. The module will then force the existing TCP connection to close.

**ATTENTION**

The **Inactivity time** should be longer than the **Force transmit** timeout. To prevent the unintended loss of data due a session getting disconnected, it is strongly recommended that this value is set large enough so that the intended data transfer is completed.

Max connection

Setting	Factory Default	Necessity
1, 2, 3, 4	1	Required

Max connection is used when the user needs to receive data from different hosts simultaneously. The factory default only allows 1 connection at a time.

Max. connection 1: The module will only allow 1 host to open the TCP connection to the specific serial port.

Max connection 2 to 4: The module will allow requests from between 2 and 4 host's TCP connection to open the serial port at the same time. When multiple hosts establish a TCP connection to the serial port at the same time, the module will duplicate the serial data and transmit to all of the hosts. Ethernet data is sent on a first-in-first-out basis to the serial port when data comes into the module from the Ethernet interface.

Delimiter 1

Setting	Factory Default	Necessity
00 to FF	"0" for None	Optional

Delimiter 2

Setting	Factory Default	Necessity
00 to FF	"0" for None	Optional

The Delimiter fields are used to specify a character or 2-character sequence which will act as a marker to control packing of serial data. By default, no delimiter characters are defined, so the module transmits data as soon as it is received. When a delimiter character or characters are defined, the module will hold data in its buffer until it receives the delimiter character or 2-character sequence. When the delimiter is received, the module will pack up the data in its buffer and send it through the Ethernet port.

Use Delimiter 1 to define the first delimiter character in hex. If only one delimiter character will be used, Delimiter 2 should be set to "0". If the delimiter will be a two-character sequence, use Delimiter 2 to define the second character. To disable the use of delimiters, set both Delimiter 1 and Delimiter 2 to "0".

Note that data packing is not only controlled by the delimiter; it is also influenced by the module's buffer size and the Force transmit field. If the delimiter has not been received by the time the 1K buffer is full, the module will pack the data for network transmission and clear the buffer. Also, if the module will also pack data for network transmission if the next byte of data is not received within the Force transmit time.

**ATTENTION**

Do not enable **Delimiter 2** if **Delimiter 1** has been disabled. The delimiter function will not work properly if Delimiter 2 is enabled without Delimiter 1.

Force transmit

Setting	Factory Default	Necessity
0 to 65535 ms	0 ms	Optional

0: The force transmit timeout is disabled.

1 to 65535: If the module does not receive the next byte of data within the time specified, it will pack the data in its buffer into the same data frame for network transmission.

The **Force transmit** field is typically used in conjunction with the Delimiter fields to specify how data in the module's buffer is packed for network transmission. When delimiters are used, the module accumulates data in its buffer as it waits to receive a delimiter. If there is a break in communication, data will be held in the buffer as the module continues to wait for a delimiter. The Force transmit field allows you to specify the maximum amount of time that the module will wait for data. With Force transmit enabled, the module will automatically pack the data in the buffer for network transmission if no data is received for the specified time.

When set to 0, Force transmit is disabled, which means there is no time limit for how long the module will wait to receive data. When set between 1 and 65535, the module will pack data as soon as there has been no serial communication for the specified time.

The optimal force transmit time depends on your application, but it should be larger than one character interval within the specified baud rate to have any effect. For example, assume that the serial port is set to 1200 bps, 8 data bits, 1 stop bit, and no parity. In this case, the total number of bits needed to send one character is 10 bits, and the time required to transfer one character is

$$(10 \text{ bits} / 1200 \text{ bits/s}) \times 1000 \text{ ms/s} = 8.3 \text{ ms.}$$

Since it requires about 9 ms to send one character, the Force transmit should be 10 ms or more to have any effect. At 9 ms or less, the module will simply pack every character as it is received, which would be the same as if no delimiter characters or Force transmit time were specified at all.

Local TCP port

Setting	Factory Default	Necessity
1 to 65535	4001	Required

Use this field to indicate the TCP port that the module will use to listen to connections, and that other devices must use to contact the module. To avoid conflicts with well known TCP ports, the default is set to 4001.

Real COM Mode

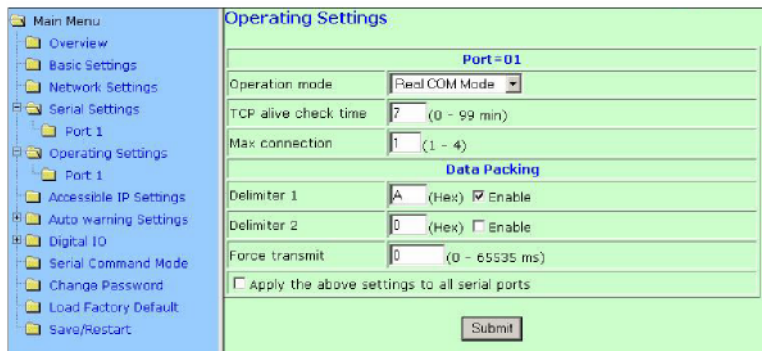

NOTE: “Serial Command Mode” is supported in firmware version 3.0 and above.

TCP alive check time

Setting	Factory Default	Necessity
0 to 99 min	7 min	Optional

0 min: The TCP connection is not closed due to an idle TCP connection.

1 to 99 min: The module automatically closes the TCP connection if there is no TCP activity for the given time. After the connection is closed, the module starts listening for another host’s TCP connection.

Max connection

Setting	Factory Default	Necessity
1, 2, 3, 4	1	Required

Max connection is used when the user needs to receive data from different hosts simultaneously. The factory default only allows 1 connection at a time. When Max Connection is set to 1, the Real COM driver on the specific host has full control.

Max. connection 1: The module will only allow 1 host’s Real COM driver to open a connection to the module’s serial port.

Max connection 2 to 4: The module will allow requests from between 2 and 4 different hosts to open the module’s serial port at the same time. When multiple hosts’ Real COM drivers open the serial port at the same time, the COM driver only provides a pure data tunnel without control ability.

Application software that is based on the COM driver will receive a driver response of “success” when the software uses any of the Win32 API functions. The firmware will only send the data back to the driver on the host.

Data will be sent first-in-first-out when data comes into the module from the Ethernet interface.



ATTENTION

When **Max connection** is greater than 1, it means that the module will be used for multi-connection applications. In multi-connection applications, when one host closes the COM port, the module will suspend serial communication with all other hosts until that host successfully closes the COM port.

In multi-connection applications, the module will use the serial communication parameters set in the console. If the host opens the COM with parameters different from the module's console setting, data communication may not work properly.

Delimiter 1

Setting	Factory Default	Necessity
00 to FF	“0” for None	Optional

Delimiter 2

Setting	Factory Default	Necessity
00 to FF	“0” for None	Optional

The Delimiter fields are used to specify a character or 2-character sequence which will act as a marker to control packing of serial data. By default, no delimiter characters are defined, so the module transmits data as soon as it is received. When a delimiter character or characters are defined, the module will hold data in its buffer until it receives the delimiter character or 2-character sequence. When the delimiter is received, the module will pack up the data in its buffer and send it through the Ethernet port.

Use Delimiter 1 to define the first delimiter character in hex. If only one delimiter character will be used, Delimiter 2 should be set to “0”. If the delimiter will be a two-character sequence, use Delimiter 2 to define the second character. To disable the use of delimiters, set both Delimiter 1 and Delimiter 2 to “0”.

Note that data packing is not only controlled by the delimiter; it is also influenced by the module's buffer size and the Force transmit field. If the delimiter has not been received by the time the 1K buffer is full, the module will pack the data for network transmission and clear the buffer. Also, if the module will also pack data for network transmission if the next byte of data is not received within the Force transmit time.



ATTENTION

Do not enable **Delimiter 2** if **Delimiter 1** has been disabled. The delimiter function will not work properly if Delimiter 2 is enabled without Delimiter 1.

Force transmit

Setting	Factory Default	Necessity
0 to 65535 ms	0 ms	Optional

0: The force transmit timeout is disabled.

1 to 65535: If the module does not receive the next byte of data within the time specified, it will pack the data in its buffer into the same data frame for network transmission.

The **Force transmit** field is typically used in conjunction with the Delimiter fields to specify how data in the module's buffer is packed for network transmission. When delimiters are used, the module accumulates data in its buffer as it waits to receive a delimiter. If there is a break in communication, data will be held in the buffer as the module continues to wait for a delimiter. The Force transmit field allows you to specify the maximum amount of time that the module will wait for data. With Force transmit enabled, the module will automatically pack the data in the buffer for network transmission if no data is received for the specified time.

When set to 0, Force transmit is disabled, which means there is no time limit for how long the module will wait to receive data. When set between 1 and 65535, the module will pack data as soon as there has been no serial communication for the specified time.

The optimal force transmit time depends on your application, but it should be larger than one character interval within the specified baud rate to have any effect. For example, assume that the serial port is set to 1200 bps, 8 data bits, 1 stop bit, and no parity. In this case, the total number of bits needed to send one character is 10 bits, and the time required to transfer one character is

$$(10 \text{ bits} / 1200 \text{ bits/s}) \times 1000 \text{ ms/s} = 8.3 \text{ ms.}$$

Since it requires about 9 ms to send one character, the Force transmit should be 10 ms or more to have any effect. At 9 ms or less, the module will simply pack every character as it is received, which would be the same as if no delimiter characters or Force transmit time were specified at all.

TCP Client Mode

Operating Settings

Port = 01

Operation mode: TCP Client Mode

TCP alive check time: 7 (0 - 99 min)

Inactivity time: 0 (0 - 65535 ms)

Data Packing

Delimiter 1: A (Hex) Enable

Delimiter 2: 0 (Hex) Enable

Force transmit: 0 (0 - 65535 ms)

TCP Client Mode

Destination IP Address

Destination IP address 1: 192.168.3.62 : 4001

Destination IP address 2: : 4001

Destination IP address 3: : 4001

Destination IP address 4: : 4001

TCP connect on: Startup Any Character

Apply the above settings to all serial ports

Submit

NOTE: “Serial Command Mode” is supported in firmware version 3.0 and above.

TCP alive check time

Setting	Factory Default	Necessity
0 to 99 min	7 min	Optional

0 min: The TCP connection is not closed due to an idle TCP connection.

1 to 99 min: The module automatically closes the TCP connection if there is no TCP activity for the given time. After the connection is closed, the module starts listening for another host's TCP connection.

Inactivity time

Setting	Factory Default	Necessity
0 to 65535 ms	0 ms	Optional

0 ms: The TCP connection is not closed due to an idle serial line.

0-65535 ms: The module automatically closes the TCP connection if there is no serial data activity for the given time. After the connection is closed, the module starts listening for another host's TCP connection.

This parameter defines the maintenance status as Closed or Listen on the TCP connection. The connection is closed if there is no incoming or outgoing data through the serial port during the specific Inactivity time.

If Inactivity time is set to 0, the current TCP connection is maintained until there is a connection close request. Even with Inactivity time is disabled, the module will still check the connection status between itself and the remote host by sending "keep alive" packets periodically. If the remote host does not respond to the packet, it assumes that the connection was closed down unintentionally. The module will then force the existing TCP connection to close.

**ATTENTION**

The **Inactivity time** should be longer than the **Force transmit** timeout. To prevent the unintended loss of data due a session getting disconnected, it is strongly recommended that this value is set large enough so that the intended data transfer is completed.

**ATTENTION**

Inactivity time is only active when **TCP connect on** is set to Any Character.

Delimiter 1

Setting	Factory Default	Necessity
00 to FF	"0" for None	Optional

Delimiter 2

Setting	Factory Default	Necessity
00 to FF	"0" for None	Optional

The Delimiter fields are used to specify a character or 2-character sequence which will act as a marker to control packing of serial data. By default, no delimiter characters are defined, so the module transmits data as soon as it is received. When a delimiter character or characters are defined, the module will hold data in its buffer until it receives the delimiter character or 2-character sequence. When the delimiter is received, the module will pack up the data in its buffer and send it through the Ethernet port.

Use Delimiter 1 to define the first delimiter character in hex. If only one delimiter character will be used, Delimiter 2 should be set to "0". If the delimiter will be a two-character sequence, use Delimiter 2 to define the second character. To disable the use of delimiters, set both Delimiter 1 and Delimiter 2 to "0".

Note that data packing is not only controlled by the delimiter; it is also influenced by the module's buffer size and the Force transmit field. If the delimiter has not been received by the time the 1K buffer is full, the module will pack the data for network transmission and clear the buffer. Also, if the module will also pack data for network transmission if the next byte of data is not received within the Force transmit time.



ATTENTION

Do not enable **Delimiter 2** if **Delimiter 1** has been disabled. The delimiter function will not work properly if Delimiter 2 is enabled without Delimiter 1.

Force transmit

Setting	Factory Default	Necessity
0 to 65535 ms	0 ms	Optional

0: The force transmit timeout is disabled.

1 to 65535: If the module does not receive the next byte of data within the time specified, it will pack the data in its buffer into the same data frame for network transmission.

The **Force transmit** field is typically used in conjunction with the Delimiter fields to specify how data in the module's buffer is packed for network transmission. When delimiters are used, the module accumulates data in its buffer as it waits to receive a delimiter. If there is a break in communication, data will be held in the buffer as the module continues to wait for a delimiter. The Force transmit field allows you to specify the maximum amount of time that the module will wait for data. With Force transmit enabled, the module will automatically pack the data in the buffer for network transmission if no data is received for the specified time.

When set to 0, Force transmit is disabled, which means there is no time limit for how long the module will wait to receive data. When set between 1 and 65535, the module will pack data as soon as there has been no serial communication for the specified time.

The optimal force transmit time depends on your application, but it should be larger than one character interval within the specified baud rate to have any effect. For example, assume that the serial port is set to 1200 bps, 8 data bits, 1 stop bit, and no parity. In this case, the total number of bits needed to send one character is 10 bits, and the time required to transfer one character is

$$(10 \text{ bits} / 1200 \text{ bits/s}) \times 1000 \text{ ms/s} = 8.3 \text{ ms.}$$

Since it requires about 9 ms to send one character, the Force transmit should be 10 ms or more to have any effect. At 9 ms or less, the module will simply pack every character as it is received, which would be the same as if no delimiter characters or Force transmit time were specified at all.

Destination IP address 1/2/3/4

Setting	Factory Default	Necessity
IP address or domain name (e.g., 192.168.1.1)	None	Required

Use this field to specify the remote hosts that the module will connect to.



ATTENTION

Up to 4 connections can be established between the module and hosts. The connection speed or throughput may be low if one of the four connections is slow. In this case, the other 3 connections will be delayed while waiting for the slowest connection to finish transmitting or receiving.



ATTENTION

The **Destination IP address** parameter can accept domain names address in place of IP addresses if a DNS server has been configured. For some applications, you may need to send the data actively to a remote destination's domain name address.

TCP connect on

Setting	Factory Default	Necessity
Start up, Any Character	Start up	Optional

Start up: The module will attempt to establish a TCP connection as soon as it is powered on.

Any Character: The module will attempt to establish a TCP connection as soon as the module starts receiving serial data.

UDP Mode

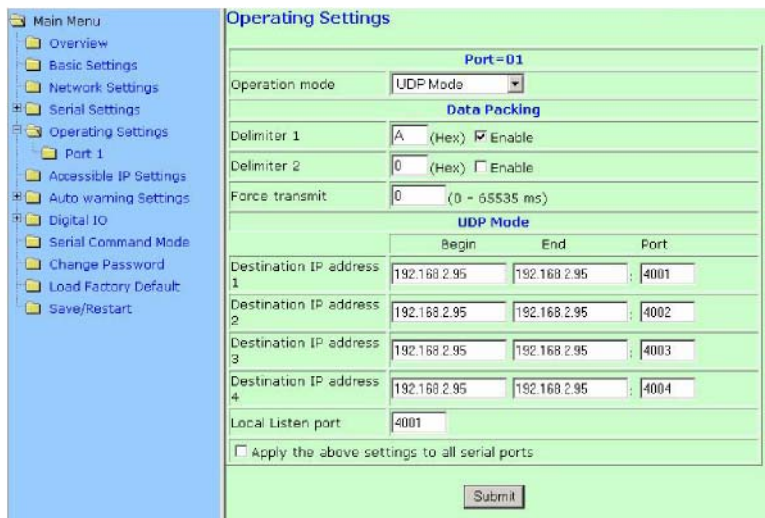

NOTE: “Serial Command Mode” is supported in firmware version 3.0 and above.

Delimiter 1

Setting	Factory Default	Necessity
00 to FF	“0” for None	Optional

Delimiter 2

Setting	Factory Default	Necessity
00 to FF	“0” for None	Optional

The Delimiter fields are used to specify a character or 2-character sequence which will act as a marker to control packing of serial data. By default, no delimiter characters are defined, so the module transmits data as soon as it is received. When a delimiter character or characters are defined, the module will hold data in its buffer until it receives the delimiter character or 2-character sequence. When the delimiter is received, the module will pack up the data in its buffer and send it through the Ethernet port.

Use Delimiter 1 to define the first delimiter character in hex. If only one delimiter character will be used, Delimiter 2 should be set to "0". If the delimiter will be a two-character sequence, use Delimiter 2 to define the second character. To disable the use of delimiters, set both Delimiter 1 and Delimiter 2 to "0".

Note that data packing is not only controlled by the delimiter; it is also influenced by the module's buffer size and the Force transmit field. If the delimiter has not been received by the time the 1K buffer is full, the module will pack the data for network transmission and clear the buffer. Also, if the module will also pack data for network transmission if the next byte of data is not received within the Force transmit time.



ATTENTION

Do not enable **Delimiter 2** if **Delimiter 1** has been disabled. The delimiter function will not work properly if Delimiter 2 is enabled without Delimiter 1.

Force transmit

Setting	Factory Default	Necessity
0 to 65535 ms	0 ms	Optional

0: The force transmit timeout is disabled.

1 to 65535: If the module does not receive the next byte of data within the time specified, it will pack the data in its buffer into the same data frame for network transmission.

The **Force transmit** field is typically used in conjunction with the Delimiter fields to specify how data in the module's buffer is packed for network transmission. When delimiters are used, the module accumulates data in its buffer as it waits to receive a delimiter. If there is a break in communication, data will be held in the buffer as the module continues to wait for a delimiter. The Force transmit field allows you to specify the maximum amount of time that the module will wait for data. With Force transmit enabled, the module will automatically pack the data in the buffer for network transmission if no data is received for the specified time.

When set to 0, Force transmit is disabled, which means there is no time limit for how long the module will wait to receive data. When set between 1 and 65535, the module will pack data as soon as there has been no serial communication for the specified time.

The optimal force transmit time depends on your application, but it should be larger than one character interval within the specified baud rate to have any effect. For example, assume that the serial port is set to 1200 bps, 8 data bits, 1 stop bit, and no parity. In this case, the total number of bits needed to send one character is 10 bits, and the time required to transfer one character is

$$(10 \text{ bits} / 1200 \text{ bits/s}) \times 1000 \text{ ms/s} = 8.3 \text{ ms.}$$

Since it requires about 9 ms to send one character, the Force transmit should be 10 ms or more to have any effect. At 9 ms or less, the module will simply pack every character as it is received, which would be the same as if no delimiter characters or Force transmit time were specified at all.

Destination IP address 1/2/3/4

Setting	Factory Default	Necessity
IP address range E.g., Begin: 192.168.1.1 End: 192.168.1.10	None	Required

Local Listen port

Setting	Factory Default	Necessity
1 to 65535	4001	Required

Use this field to specify the UDP port that the module listens to and that other devices must use to contact the module. To avoid conflicts with well known UDP ports, the default is set to 4001.

Accessible IP Settings

NOTE: “Serial Command Mode” is supported in firmware version 3.0 and above.

The module uses an IP address based filtering method to control access. **Accessible IP Settings** allows you to specify a list of IP addresses or IP address ranges that are authorized to access the module.

To allow access to a specific IP address

Enter the IP address in the corresponding field; enter **255.255.255.255** for the netmask.

To allow access to hosts on a specific subnet

For both the IP address and netmask, use **0** for the last digit (e.g., **192.168.1.0** and **255.255.255.0**).

To allow unrestricted access

Deselect the **Enable the accessible IP list** option.

Refer to the following table for more configuration examples.

Allowed hosts	Entered IP address/Netmask
Any host	Disable
192.168.1.120	192.168.1.120 / 255.255.255.255
192.168.1.1 to 192.168.1.254	192.168.1.0 / 255.255.255.0
192.168.0.1 to 192.168.255.254	192.168.0.0 / 255.255.0.0
192.168.1.1 to 192.168.1.126	192.168.1.0 / 255.255.255.128
192.168.1.129 to 192.168.1.254	192.168.1.128 / 255.255.255.128

Auto Warning Settings

E-mail and SNMP Trap

NOTE: “Serial Command Mode” is supported in firmware version 3.0 and above.

Mail server

Mail server

Setting	Factory Default	Necessity
IP or Domain Name	None	Optional

User name

Setting	Factory Default	Necessity
1 to 15 characters	None	Optional

Password

Setting	Factory Default	Necessity
1 to 15 characters	None	Optional

From E-mail address

Setting	Factory Default	Necessity
1 to 63 characters	NE _[Serial No.]@[NE4100 Series Module Name]	Optional

E-mail address 1/2/3/4

Setting	Factory Default	Necessity
1 to 63 characters	None	Optional



ATTENTION

Consult your network administrator or ISP for the proper mail server settings. The Auto warning function may not work properly if not set up properly. NE-4100 Series SMTP AUTH supports LOGIN, PLAIN, CRAM-MD5 (RFC 2554).

SNMP trap server

SNMP trap server IP or domain name

Setting	Factory Default	Necessity
IP or Domain Name	None	Optional

Event Type

Event Type		
Cold start	<input checked="" type="checkbox"/> Mail	<input checked="" type="checkbox"/> Trap
Warm start	<input checked="" type="checkbox"/> Mail	<input checked="" type="checkbox"/> Trap
Authentication failure	<input type="checkbox"/> Mail	<input type="checkbox"/> Trap
IP address changed	<input type="checkbox"/> Mail	
Password changed	<input type="checkbox"/> Mail	
DCD changed		
Port	<input type="checkbox"/> Mail	<input type="checkbox"/> Trap
Port 1	<input checked="" type="checkbox"/> Mail	<input checked="" type="checkbox"/> Trap
DSR changed		
Port	<input type="checkbox"/> Mail	<input type="checkbox"/> Trap
Port 1	<input checked="" type="checkbox"/> Mail	<input checked="" type="checkbox"/> Trap

NOTE: “Serial Command Mode” is supported in firmware version 3.0 and above.

On the **Event Type** page, you may configure how administrators are notified of certain system, network, and configuration events. Depending on the event, different options for automatic notification are available, as shown above. **Mail** refers to sending an e-mail to a specified address. **Trap** refers to sending an SNMP trap. The following items are events that can trigger an automatic warning.

Cold start

The module is started from a power off state. If this is selected, automatic notification is sent if the module is powered off and then powered on again.

Warm start

The module is restarted without turning the power off. If this is selected, automatic notification is sent if the module is rebooted while still powered on.

Authentication failure

The user inputs a wrong password from the console or Network Enabler Administrator. If this is selected, automatic notification is sent if a user attempts to unlock the module and enters the wrong password.

IP address changed

The module's IP address has been changed. If this is selected, the module will attempt to send an e-mail before it reboots with a new IP address. If the module fails to reach the mail server after 15 seconds, it will reboot anyways and no notification will be sent.

Password changed

The module's password has been changed. If this is selected, the module will attempt to send an e-mail before it reboots with a new password. If the module fails to reach the mail server after 15 seconds, it will reboot anyways and no notification will be sent.

DCD changed, DSR changed

DCD (Data Carrier Detect) and DSR (Data Set Ready) signals indicate serial communication status. Administrators can receive e-mail and SNMP trap warnings when there is a status change to the serial port. For example, a DCD change to high also means “Connected” between local modem and remote modem. If the DCD signal changes to low, it also means that the connection line is down. A DSR change to high means that the Data Circuit-Terminating Equipment (DCE) is powered ON. If the DSR signal changes to low, it also means that the DCE is powered off.



ATTENTION

DCD changed and DSR changed events are not available for RS-422 or RS-485 modules, because those standards do not use DCD and DSR signals.

Digital IO

DIO Settings

No.	Mode	Status
DIO 0	IN	Ⓕ L Ⓒ H
DIO 1	IN	Ⓕ L Ⓒ H
DIO 2	IN	Ⓕ L Ⓒ H
DIO 3	IN	Ⓕ L Ⓒ H

TCP Port: 5001

SW Reset Function (Use DIO 1): Disable

Submit

NOTE: “Serial Command Mode” is supported in firmware version 3.0 and above.

The DIO Settings page is where each DIO channel is configured. Use **Mode** to specify either digital input or digital output operation. IN is for digital input operation, where the channel’s status is controlled by an external digital switch. OUT is for digital output operation, where the channel transmits a high or low signal. Use **Status** to control high or low status for digital output channels; Status setting will be ignored for digital input channels.

TCP Port is the port number that will be reserved for DIO commands. DIO commands may be used to control and obtain data from the module’s DIO channels. Please refer to Appendix D for additional information on DIO commands.

SW Reset Function (Use DIO 1) is used to enable or disable the use of DIO 1 as a reset button. When SW Reset is enabled, DIO 1 will be forced to digital input mode and will act as a reset button. Pulling DIO 1 “low” for 3 seconds will erase the password, and pulling DIO 1 “low” for 10 seconds will load the factory defaults. This function is disabled by default.

Note that any changes will not take effect until you click **Submit** to validate the modifications.

DIO Monitor

The DIO Monitor page polls and displays the mode and status of each DIO channel. You may use this page to verify changes that were made in the DIO Settings page.

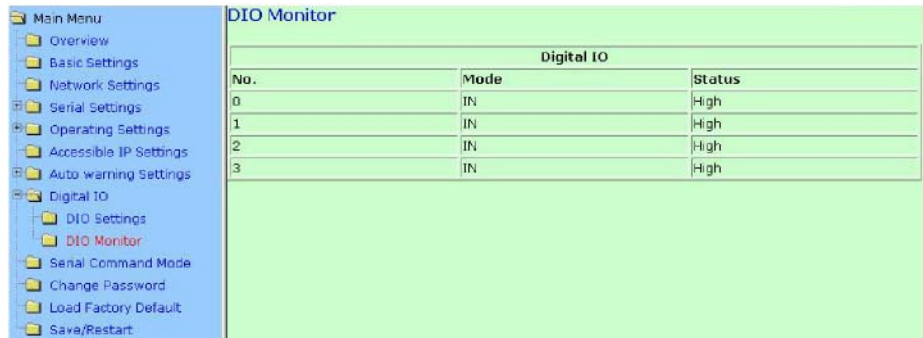

Digital IO		
No.	Mode	Status
0	IN	High
1	IN	High
2	IN	High
3	IN	High

NOTE: “Serial Command Mode” is supported in firmware version 3.0 and above.

Serial Command Mode

Serial command mode is a special mode for configuring the module through the serial device itself. It is supported in firmware version 3.0 and above. Please refer to Chapter 9 for information on Serial Command Mode.

Change Password

Click on **Change Password** in the navigation panel to display the **Change Password** window.



NOTE: “Serial Command Mode” is supported in firmware version 3.0 and above.

Enter the old password and new passwords and click on **Submit**. To remove password protection, leave the new password blank and just enter the old password.



ATTENTION

If you forget the password, the **ONLY** way to configure the module is to “load factory defaults.”

Remember to export the configuration file with Network Enabler Administrator after you have finished configuring the module. Your configuration can then be imported back into the module if you have to load the factory defaults. Please refer to Chapter 7 for more details about importing and exporting the module’s configuration.

Load Factory Defaults

To load the factory default settings, click on **Load Factory Default** in the navigation panel and then click on **Submit**. All previous modifications will be lost.

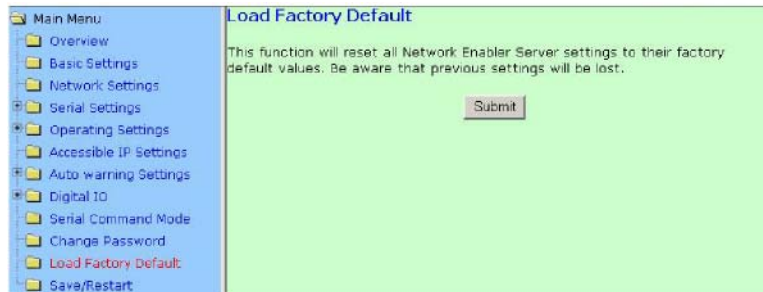

NOTE: “Serial Command Mode” is supported in firmware version 3.0 and above.

Save/Restart

Click on **Save/Restart** in the navigation panel to save all submitted changes and restart the module.

Network Enabler Administrator

Network Enabler Administrator is a Windows utility that can be used to configure NE-4100 Series modules. In this chapter, we will discuss how to install and use Network Enabler Administrator.

This chapter includes the following sections:

- ❑ **Overview**
- ❑ **Installing Network Enabler Administrator**
- ❑ **Network Enabler Administrator Navigation**
- ❑ **Configuration Functions**
 - Broadcast Search
 - Specify by IP Address
 - Locate
 - Unlock
 - Configure
 - Upgrade Firmware
 - Import and Export Configuration
- ❑ **Monitor Functions**
 - Add and Remove Target
 - Load Configured COM Port
 - Settings
 - Go and Stop
- ❑ **Port Monitor Functions**
- ❑ **COM Mapping Functions**
 - Add and Remove Target
 - COM Settings
 - Enable and Disable
 - Apply and Discard Change
 - Import and Export COM Mapping
- ❑ **IP Address Report Functions**

Overview

NE-4100 Series modules are shipped with an integrated software suite that bundles Network Enabler Administrator and the IP Serial Library. The suite provides everything you need to remotely manage, monitor, and modify the module—hassle free.

Network Enabler Administrator organizes commands into logical groups to simplify the installation process. It allows off-line COM mapping and provides monitoring and IP location server functions. In addition, you may import and export the module's configuration for backup or duplication into another module.

Installing Network Enabler Administrator

1. Open the Setup program and click **Yes** to proceed.

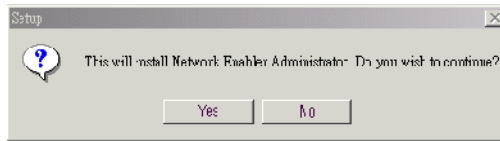

2. Click **Next** when the **Welcome** window opens to proceed with the installation.

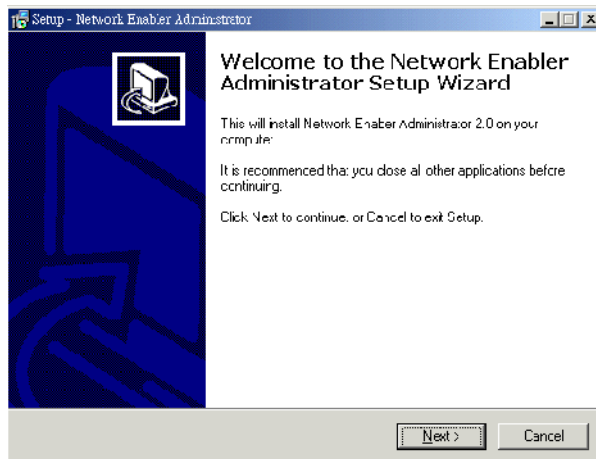

3. Click **Next** when the **Select Additional Tasks** window opens to proceed with the installation.

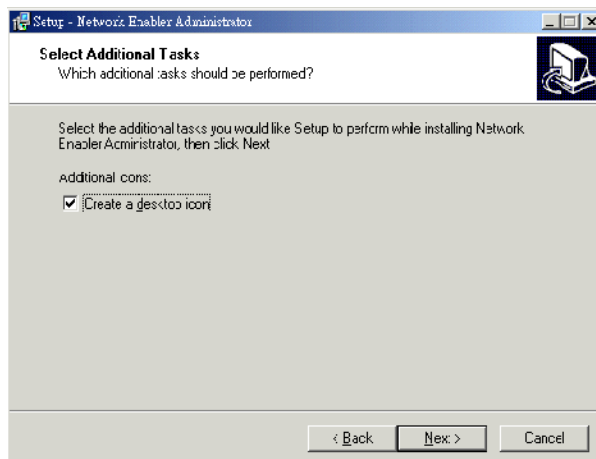

- Click **Install** to install program files in the default directory.

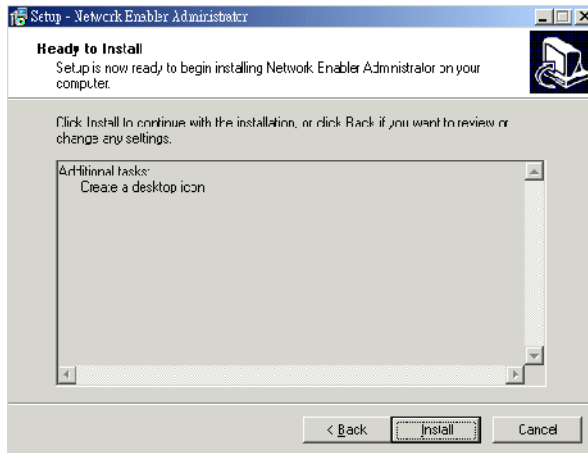

- The **Installing** window will report the progress of the installation.

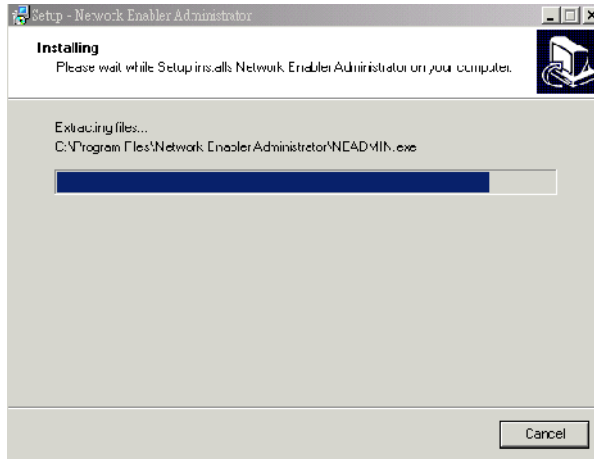

- Click **Finish** to complete the installation of Network Enabler Administrator.

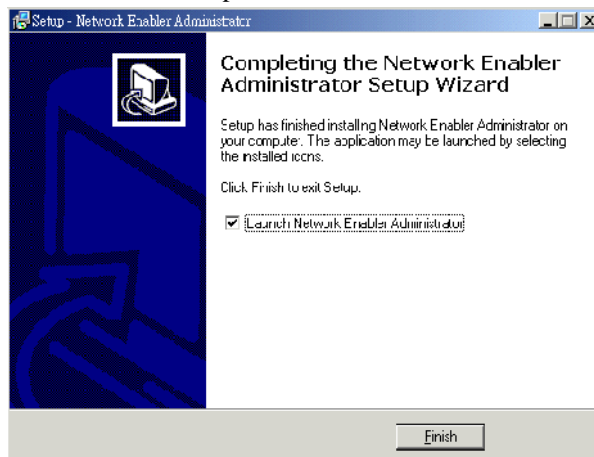

Network Enabler Administrator Navigation

The Network Enabler Administrator-Configuration window is divided into four parts.

- The top section is the menu and help area. Please note that the help file is not compatible with Windows NT
- The left panel is the navigation panel and lists the available types of functions. The same list is shown in the Function menu on the menu bar.
- The right panel is the module list. When activating a function, the module list is where the target module for that function is selected.
- The bottom section is the log area, which shows a record of status and processing messages.

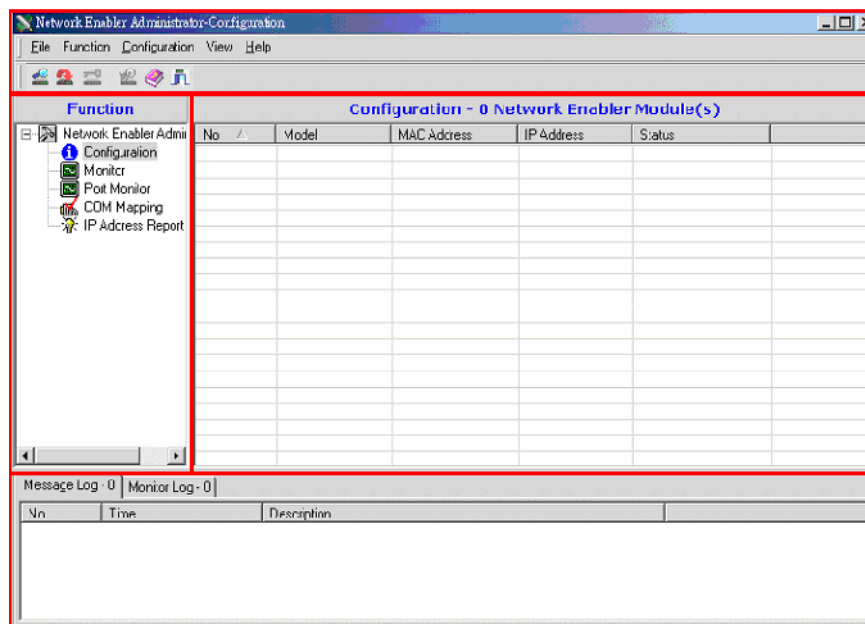

All functions are accessed by first selecting the type of function, then selecting the target module in the module list, and finally selecting the specific function:

1. The available types of functions are listed in the navigation panel and in the Function menu in the menu bar. Click the desired type in the navigation panel, or select it from the menu bar. Once the type of function is selected, the right panel will show the list of modules that may be used for the selected functions.
2. Modules that have been detected by Network Enabler Administrator are listed in the right panel. Click the desired target module in the module list. Note that each type of function has its own independent module list.
3. Specific functions are accessed in the context menu. The context menu is different for each type of function and may be opened in three different ways:
 - With the type of function already selected in the navigation panel, right-click the target module in the module list to bring up the context menu.
 - With the target module already selected in the module list, right-click the desired type of function to bring up the context menu.
 - With the type of function already selected in the navigation panel and the target module already selected in the module list, open the context menu from the menu bar.

From the context menu, you may then select the desired function.

Configuration Functions

Configuration functions are where module parameters may be viewed and changed. All parameters available in the web console are also available here. In addition, a module's configuration may be imported or exported and the firmware may be updated. Note that the module list must be manually updated every time Configuration functions are accessed.



ATTENTION

Every time Configuration functions need to be used, you must first use **Broadcast Search** or **Specify by IP Address** to add the module to the Configuration module list. The Configuration module list is not retained when other functions are used.



ATTENTION

When Network Enabler Administrator is first opened, you must use **Broadcast Search** or **Specify by IP Address** to find the module in order to unlock other functions.

Broadcast Search

Broadcast Search is used to find all NE-4100 Series modules that are connected to the same LAN as your computer. Since the Broadcast Search function searches by MAC address and not IP address, all NE-4100 Series modules connected to the LAN will be located, regardless of whether or not they are part of the same subnet as the host. If you have trouble detecting the module, please verify your network settings and connection.

1. Select **Broadcast Search** from the **Configuration** context menu. Note that this menu may also be opened by right-clicking **Configuration** in the navigation panel.

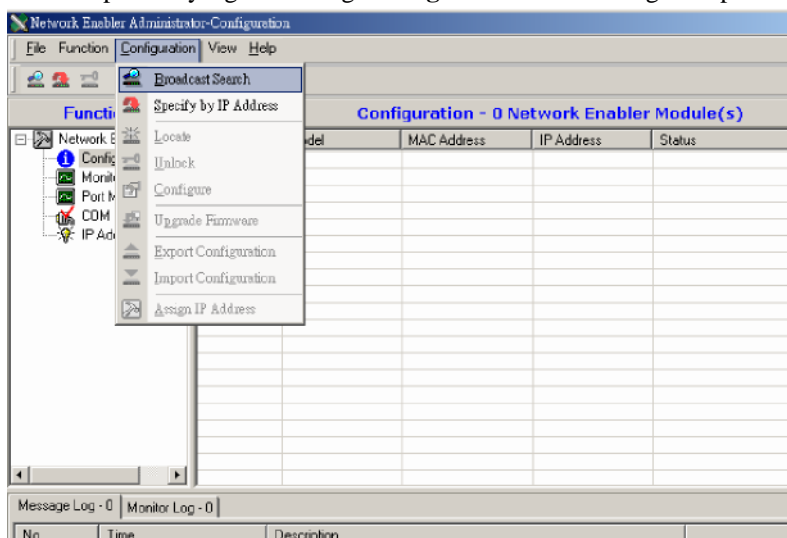

2. A **Searching** window will open, showing that the program is searching for NE-4100 Series modules connected to this network. You may click **Stop** as soon as the desired module is found.

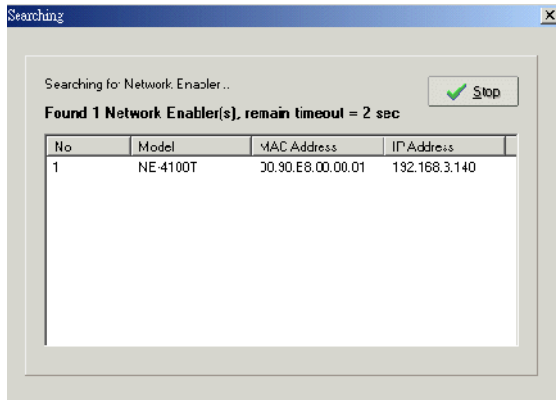

3. After the search is finished, all modules that were found will be shown in the **Configuration** module list. Select the desired module to begin using other functions with it. If you locate more than one module connected to this network, use the MAC address to determine which module you wish to configure.

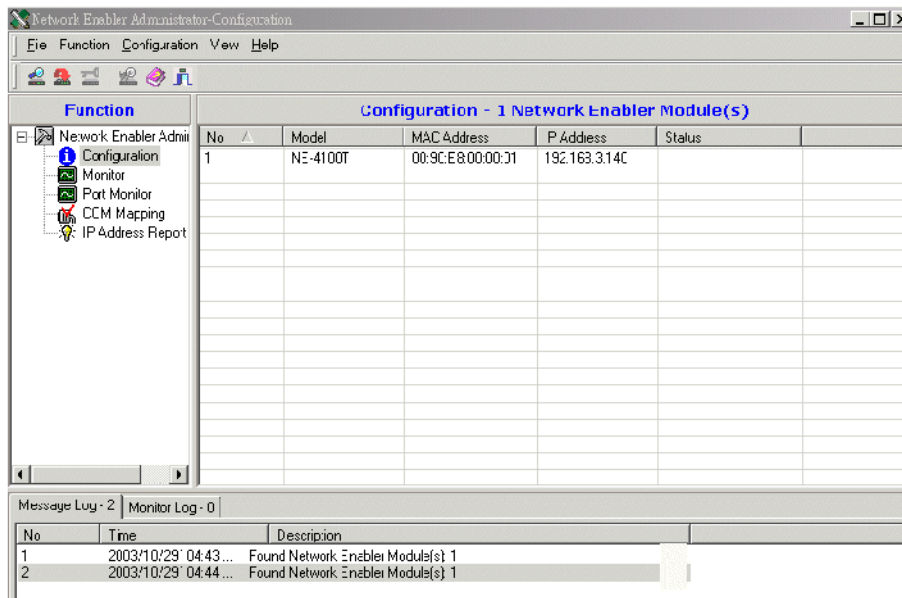

Specify by IP Address

Specify by IP Address is used to search the network for a specific module by its IP address. When the module is found, it is added to the **Configuration** module list and may be selected for use with other functions. If you have trouble detecting the module, please verify your network settings and connection.

Locate

Locate sends a signal to make the selected module's "Ready" LED blink, which makes it easier to locate the module if you are managing multiple modules at the same time. The module does not have a built-in LED, but the evaluation board maps the signal to its own onboard LED. Please refer to Pin Assignments in Chapter 2 for information on which pin is associated with the "Ready" LED. Click **Stop** to turn off the Locate function.

Unlock

Unlock is used to enter the password of locked modules in order to view and changes settings. In the **Configuration** module list, the Status field shows the password status of the module, as follows:

Status	Description
Lock	The module is password protected, Broadcast Search was used to locate it, and the password has not yet been entered.
Unlock	The module is password protected, Broadcast Search was used to locate it, and the password has been correctly entered. Henceforth during this Network Enabler Administrator session, activating various utilities for this module will not require re-entering the password.
Blank	The module is not password protected, and Broadcast Search was used to locate it.
Fixed	The module is not password protected, and Specify by IP address was used to locate it. Note that the term Fixed is borrowed from the standard fixed IP address networking terminology.
Lock Fixed	The module is password protected, Specify by IP address was used to locate it, and the password has not yet been entered from within the current Network Enabler Administrator session.

If the module is password protected, you will see the following message when you try to access most functions.

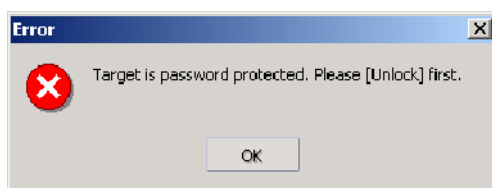

You will need to unlock the module to make any modifications to the module's configuration.

1. Select **Unlock** from the **Configuration** context menu. Note that this menu may also be opened by right-clicking **Configuration** in the navigation panel, or by right-clicking the selected module.

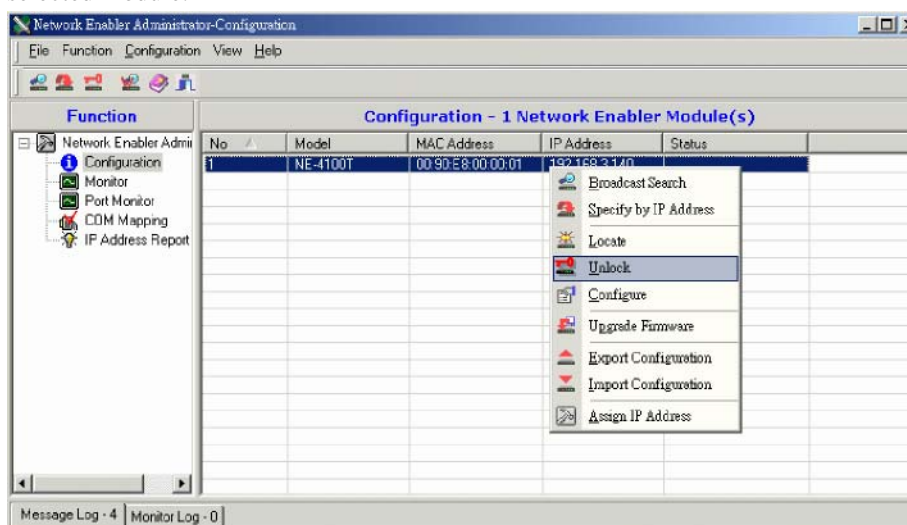

2. After entering the correct password, the following window will open.



After a module has been unlocked, it remains unlocked for the duration of the Network Enabler Administrator session, even if a new password is assigned.



ATTENTION

The **Unlock** function only allows you to enter the current password. To set or change the module's password, select the **Configure** command in the **Configuration** context menu.

Configure

Configure is used to change the selected module's settings. All web console settings are available here

1. Select **Configure** from the **Configuration** context menu. Note that this menu may also be opened by right-clicking **Configuration** in the navigation panel, or by right-clicking the selected module.

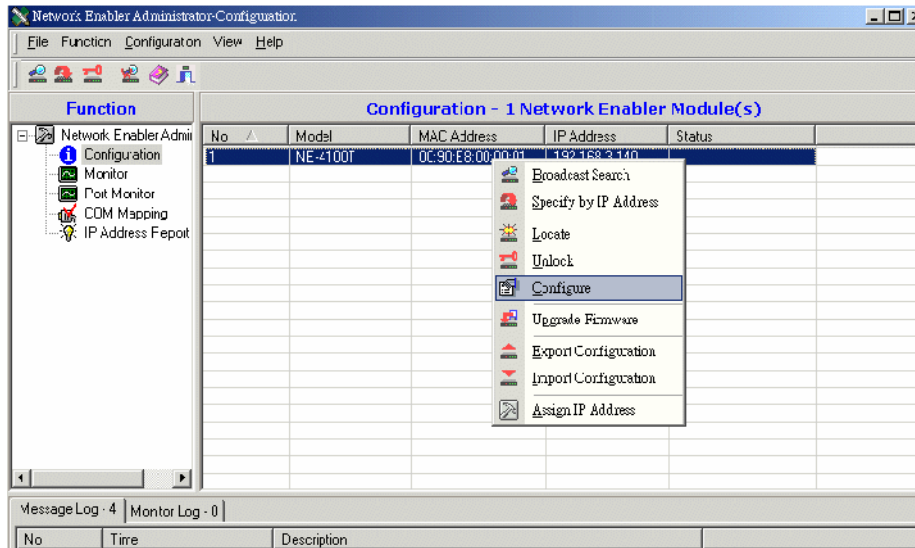

2. The next window shows that the module's configuration is being processed.

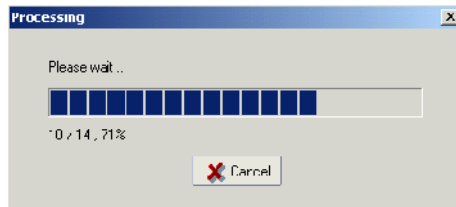

3. After the processing is done, the following window will open.

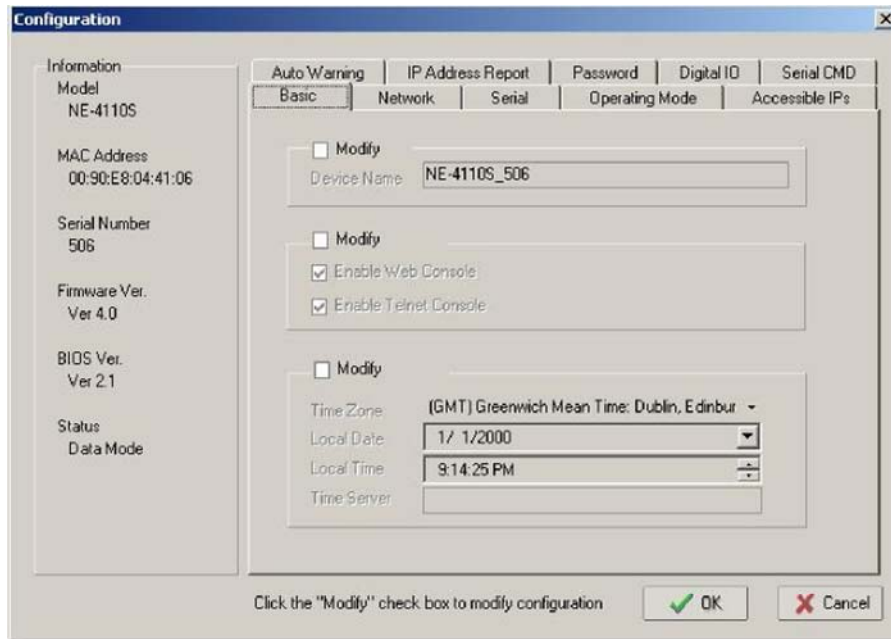

NOTE: “Serial Command Mode” is supported in firmware version 3.0 and above.

The module’s parameters are divided into ten tabs—**Basic, Network, Serial, Operating Mode, Accessible IPs, Auto Warning, IP Address Report, Password, Digital IO, and Serial CMD**. To make changes to any settings, the **Modify** box must be checked. The changes will be made effective after you click **OK**, which will save all changes and restart the module. Please refer to Chapter 6 for descriptions of each parameter.



ATTENTION

You may simultaneously modify the configurations of multiple modules as long as the modules are all the same model. To select multiple modules in the module list, hold down the Ctrl key while selecting the desired modules in the Configuration window, or hold down the Shift key to select a group of modules.

Upgrade Firmware

Upgrade Firmware is used to upload new firmware to the selected module.

1. Select **Upgrade Firmware** from the **Configuration** context menu. Note that this menu may also be opened by right-clicking **Configuration** in the navigation panel, or by right-clicking the selected module.

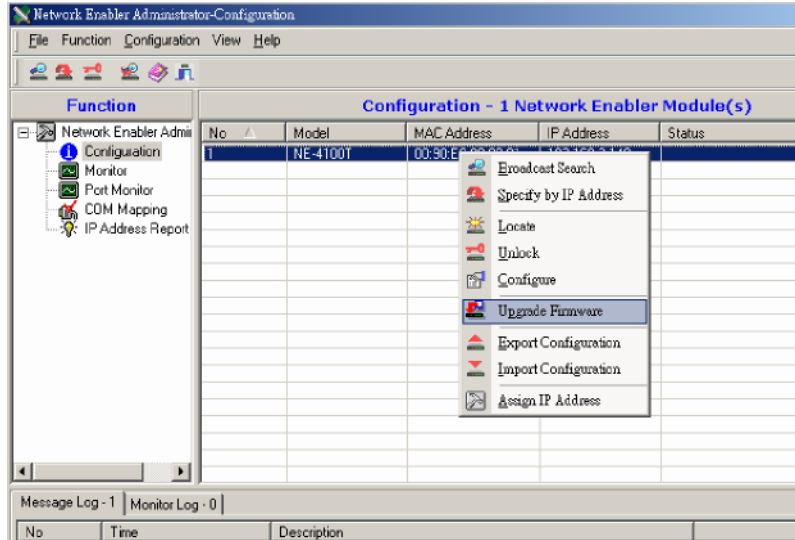

2. Select the ROM file to be downloaded to the module. You may download the latest firmware at www.moxa.com.

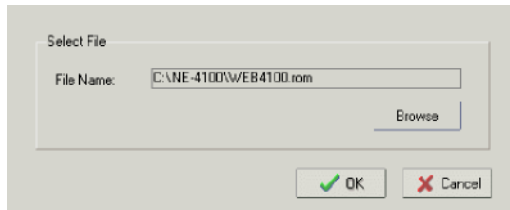

3. The window will indicate when the firmware has been successfully updated. Do not interrupt processing while the firmware is being updated.

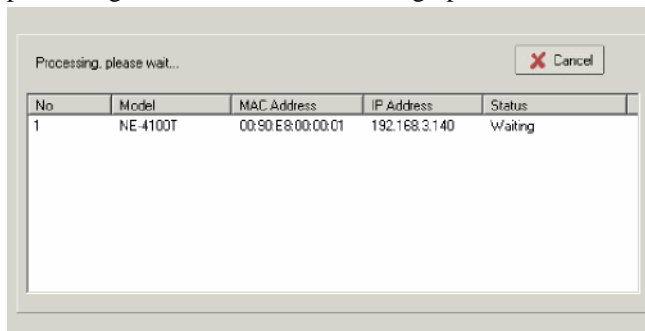

ATTENTION

You may simultaneously upgrade the firmware of multiple modules as long as the modules are all the same model. To select multiple modules in the module list, hold down the Ctrl key while selecting each module, or hold down the Shift key to select a block of modules.

Import and Export Configuration

The module's configuration can be imported from a configuration text file by right-clicking the module and selecting **Import Configuration** in the **Configuration** context menu. Note that this menu may also be opened by right-clicking **Configuration** in the navigation panel, or by right-clicking the selected module.

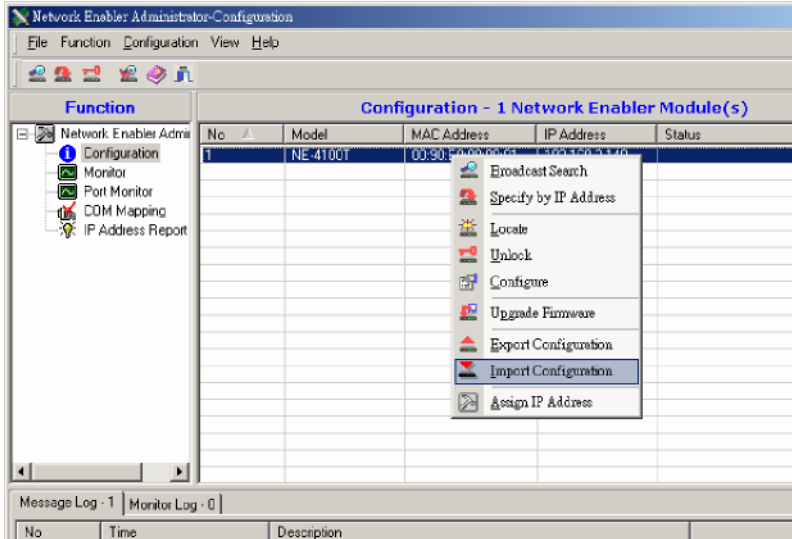

The module's configuration may be exported to a text file by selecting **Export Configuration** in the **Configuration** context menu. Note that this menu may also be opened by right-clicking **Configuration** in the navigation panel, or by right-clicking the selected module.

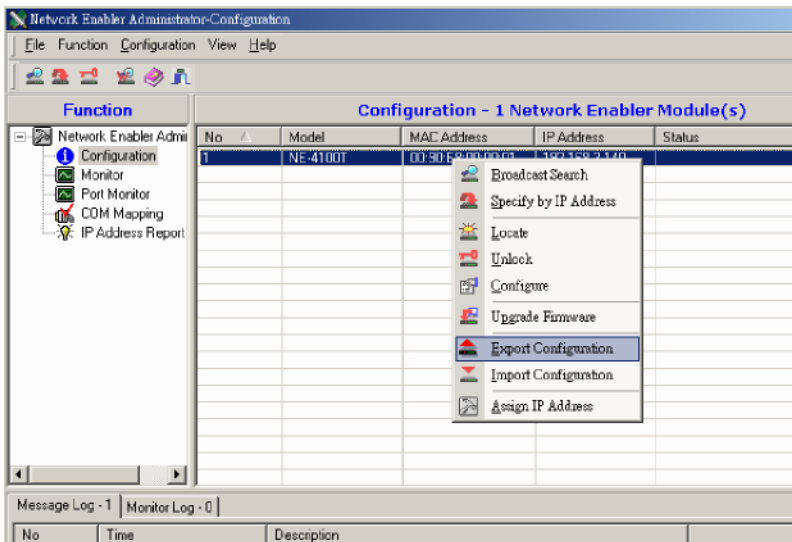

ATTENTION

You can simultaneously import the same configuration file into multiple modules as long as the modules are all the same model. To select multiple modules in the module list, hold down the Ctrl key while selecting each module, or hold down the Shift key to select a block of modules.

Monitor Functions

Monitor functions allow the monitoring of the selected module's connection and other basic settings over the network. Modules are added to the module list using **Add Target** or **Load Configured COM Port**.

Add and Remove Target

Initially, there will be no modules in the **Monitor** module list. **Add Target** is used to search for modules over the network to add to the **Monitor** module list. **Remove Target** is used to delete the selected items from the **Monitor** module list.

1. Search for the module to add to the **Monitor** module list by selecting **Add Target** in the **Monitor** context menu. Note that this menu may also be opened by right-clicking **Monitor** in the navigation panel.

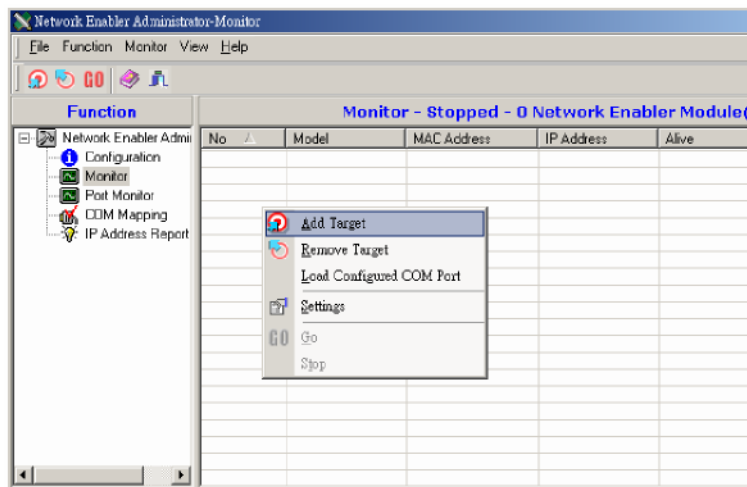

2. There are three options for adding a module:
 - If the module already shows up, you may select it with a check mark and then click **OK**.
 - If the module does not show up, you may do a broadcast search for the module by clicking **Rescan**.
 - You may manually specify the IP address of the module by selecting **Input manually** and entering the address.

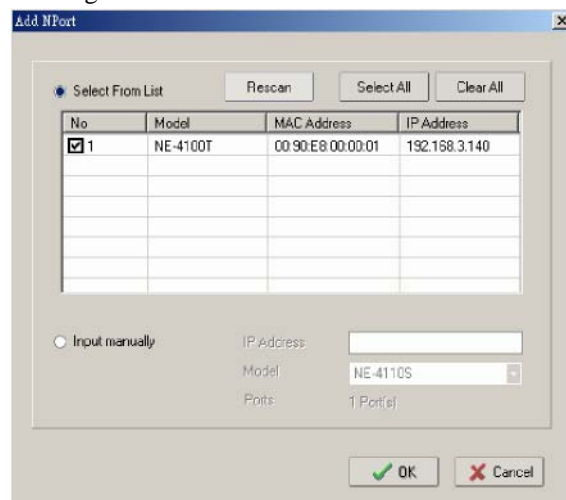

- Once the target has been selected, it will show up on the list in the **Monitor** module list. Note that monitoring does not actually begin until **Go** is selected from the context menu.

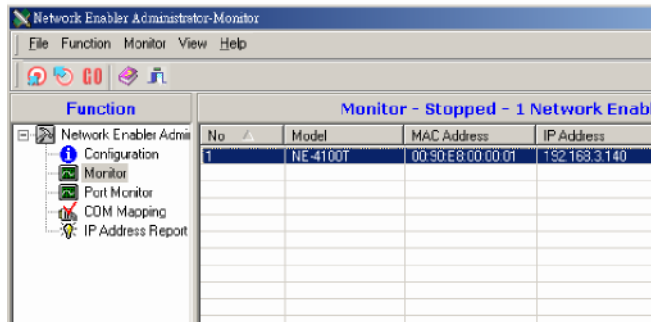

Load Configured COM Port

Load Configured COM Port searches your PC for any COM ports that have already been mapped to a network module and adds that module to the **Monitor** module list. Select **Load Configured COM Port** in the **Monitor** context menu.

Settings

Settings is used to determine what items of information are monitored, how often the information is refreshed, and how notification of events will occur.

Select **Settings** in the **Monitor** context menu. Note that this menu may also be opened by right-clicking **Monitor** in the navigation panel or by right-clicking the desired module.

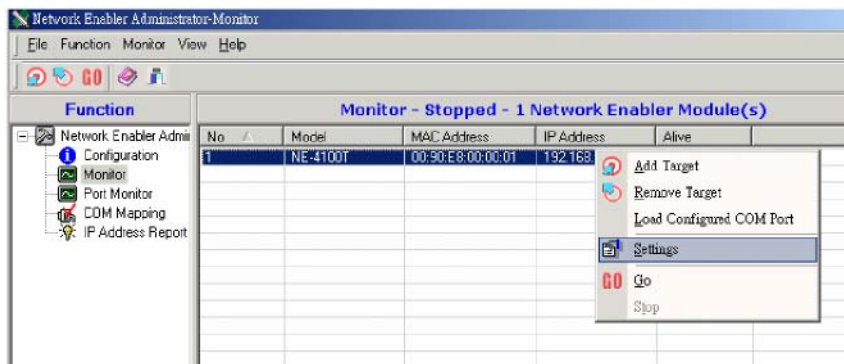

Monitor Items

In the **Monitor Items** tab, you may select which items of information will be monitored.

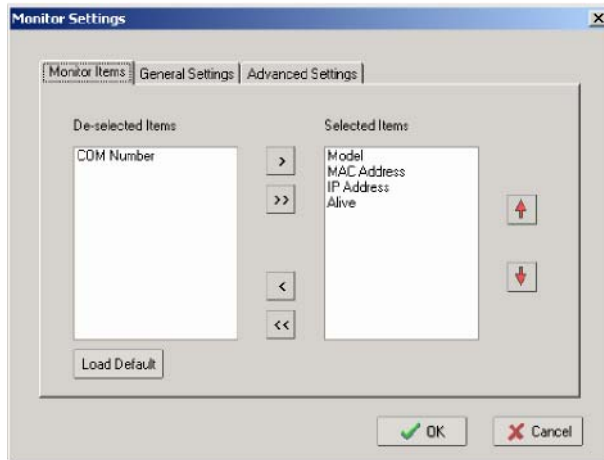

General Settings

In the **General Settings** tab, you may select how often the module is monitored, which is known as the refresh rate. The default is 3 seconds.

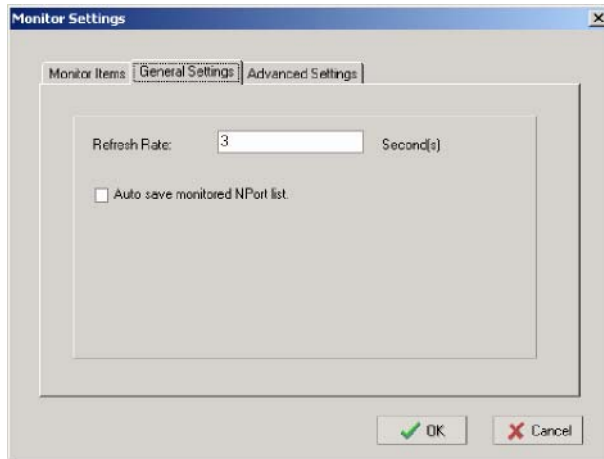

Advanced Settings

In the **Advanced Settings** tab, you may enable an alarm to warn you of monitor events. You may choose an audible alarm as well as a pop-up warning message.

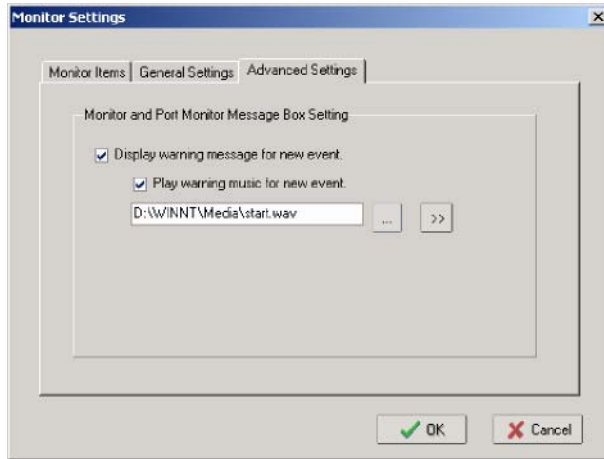

Go and Stop

Go and **Stop** are used to activate and deactivate monitoring of the modules in the module list. Monitoring is not active until **Go** has been selected in the **Monitor** context menu. Note that this menu may also be opened by right-clicking **Monitor** in the navigation panel or by right-clicking the desired module.

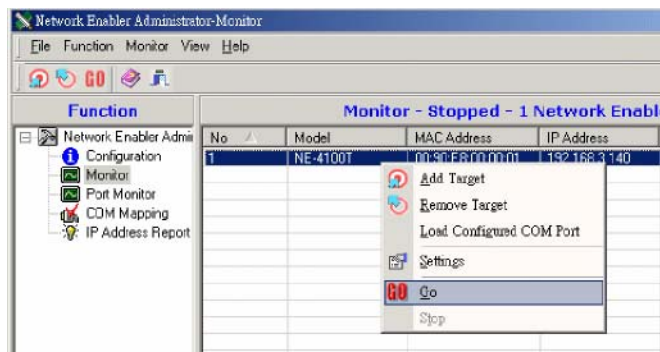

The list in the monitor window will now be live, and the selected items will be refreshed as configured.

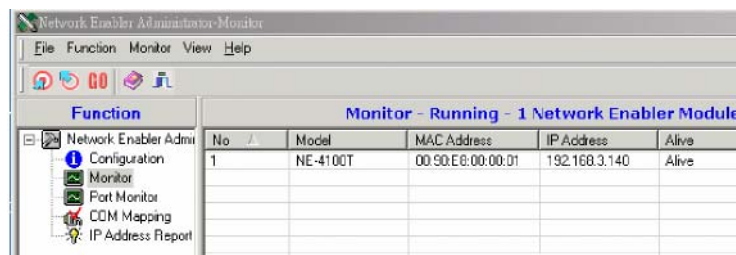

If a monitored module loses its connection with Network Enabler Administrator, a warning message will appear and an audible alarm will sound, as configured in the **Monitor** settings.

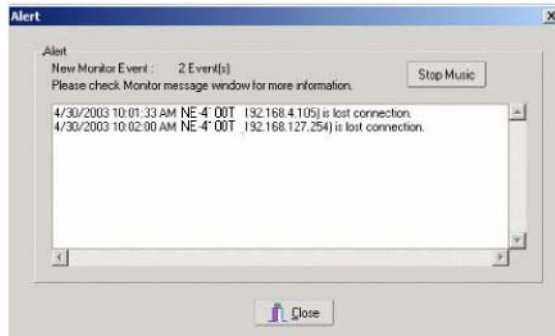

If the module's connection is restored, another message will be displayed, as configured in the **Monitor** settings.

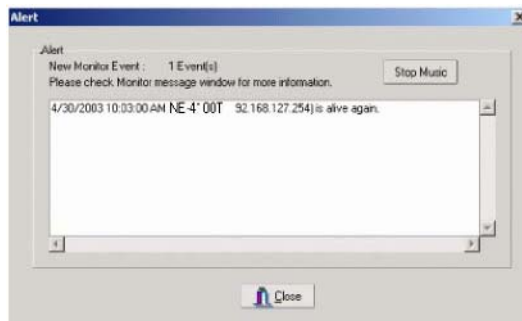

To suspend monitoring, select **Stop** from the **Monitor** context menu.

Port Monitor Functions

Port Monitor functions are very similar to **Monitor** functions, but with many additional items that can be monitored, as shown below.

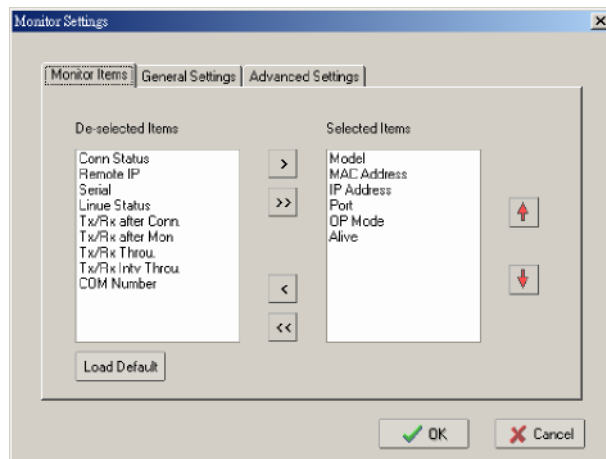

In addition, individual COM ports in the module list may be selected or deselected for monitoring.

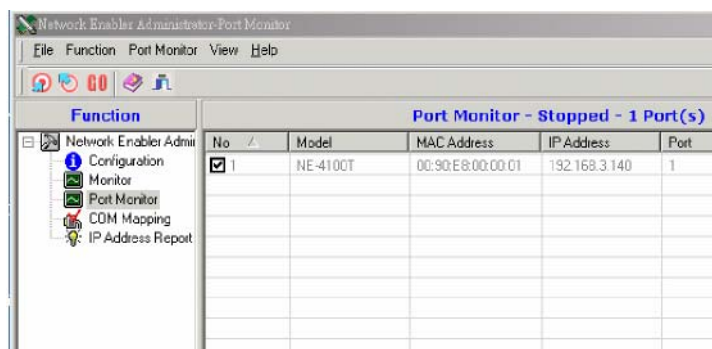

COM Mapping Functions

Network Enabler Administrator is installed with Real COM drivers that work with Windows 95 and above. These drivers map a COM port on the host PC to the module, so an application communicating with COM5, for example, could transparently be connected to the module. COM ports may be mapped before the module is connected. It is also possible to map sequential COM ports to different modules at the same time.

COM Mapping functions are used to configure, enable, and disable the module's Real COM drivers. After the COM mappings have been configured and enabled, Network Enabler Administrator is not needed for the COM mappings to remaining effect. If the PC is rebooted, the COM mappings will still be in effect after booting up.

Add and Remove Target

Add Target searches for modules over the network to add to the **COM Mapping** module list.

Remove Target deletes the selected items from the **COM Mapping** COM port list. Please refer to the Monitor section earlier in this chapter for additional details on **Add Target** and **Remove Target**.

COM Settings

COM Settings is used to assign the local COM port number to the selected module, adjust the module's serial settings, and adjust some advanced settings. Select **COM Settings** in the **COM Mapping** context menu. Note that this menu may also be opened by right-clicking **COM Mapping** in the navigation panel or by right-clicking the desired module in the module list.

Multiple modules may be selected for configuration at the same time. Remember to use **Apply Change** to save your changes, or **Discard Change** to undo the changes. To activate the mappings, use **Enable**.

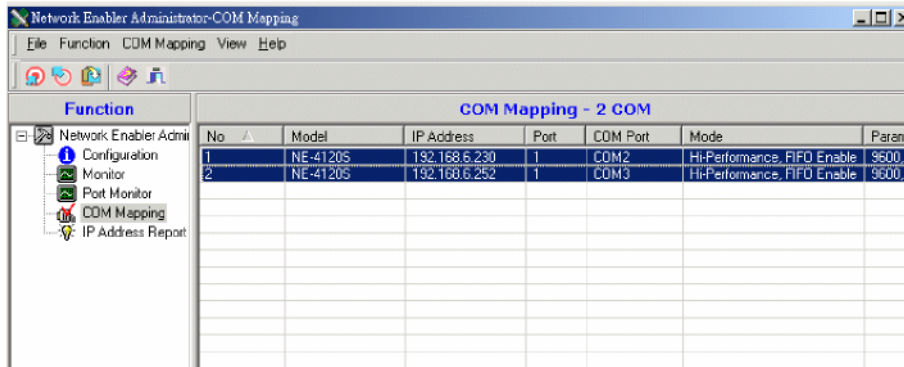

Basic Settings

In the **Basic Settings** tab, you may map a local COM port number to the selected module.

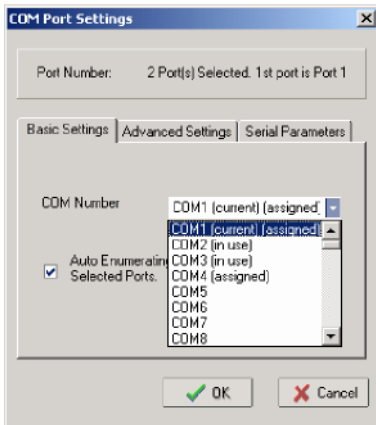

Make sure that **Auto Enumerating COM Number for Selected Ports** is checked when using mapping to multiple modules. When checked, this option automatically assigns available COM numbers sequentially. If not checked, each module will have to be manually assigned a COM port number.

Advanced Settings

In the **Advanced Settings** tab, you may configure how serial data is transmitted over the network.

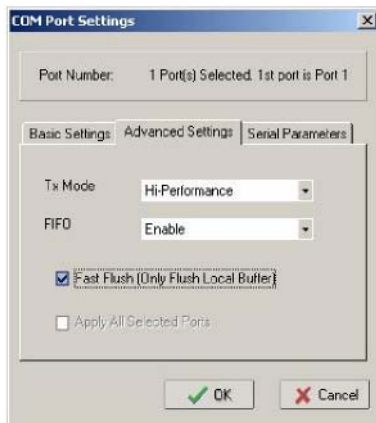

When Tx Mode is set to **Hi-Performance**, the Real COM driver sends a “Tx Empty” signal to the host as soon as it sends serial data over the network to the selected module. In Hi-performance mode, the driver will not verify that the module has successfully received and passed the data to the serial device. When Tx Mode is set to **Classical**, the driver sends the “Tx Empty” signal only after the module has confirmed that serial data has been successfully passed on to the serial device. The additional step of verification, plus the fact that it must be transmitted over the network, means that Classical mode will cause lower throughput. If you want to ensure that all data is sent out before further processing, Classical mode is recommended.

When **FIFO** is disabled, the selected module will send one byte each time the Tx FIFO becomes empty, and an Rx interrupt will be generated for each incoming byte. This will cause a faster response time but lower throughput. If you want to use XON/XOFF flow control, we recommend setting FIFO to Disable.

Fast Flush is designed to improve response time for applications that use the Win32 “PurgeComm()” function. When Fast Flush is enabled, the Real COM driver automatically flushes the buffer when it receives the “PurgeComm()” function call. When disabled, applications that use the Win32 “PurgeComm()” function may perform markedly slower, because the Real COM driver will repeatedly query the module to make sure no data is queued in the buffer instead of just flushing the buffer. The repeated queries can cause a performance hit due to the additional time spent communicating over the network, typically about several hundred milliseconds when compared to local COM ports (physically on the PC). If your application uses PurgeComm() and performance seems sluggish, try enabling Fast Flush.

Serial Parameters

In the **Serial Parameters** tab, you may configure the selected module's baud rate, parity, data bits, stop bits, and flow control. The parameters shown below are the default settings.

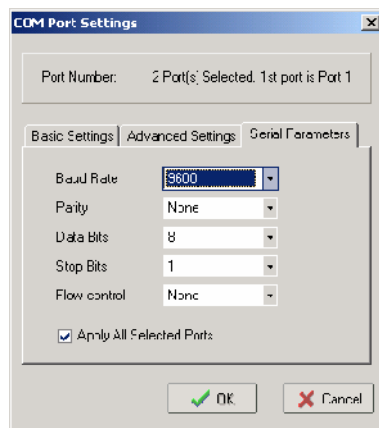

Enable and Disable

Enable and **Disable** are used to activate or deactivate the selected module's COM mapping settings. Note that this menu may also be opened by right-clicking **COM Mapping** in the navigation panel or by right-clicking the desired module. COM port mappings may be individually enabled or disabled.

Once a module's COM mappings have been enabled, the Real COM driver will operate independently of Network Enabler Administrator. The mappings will be active whether or not Network Enabler Administrator is open.

Apply and Discard Change

Apply Change and **Discard Change** are used to save or delete any changes COM mapping settings. Select **Apply Change** in the **COM Mapping** context menu to save any changes made to the COM mappings; select **Discard Change** to undo any changes that were made to the COM mappings. Note that this menu may also be opened by right-clicking **COM Mapping** in the navigation panel or by right-clicking the desired module.

Import and Export COM Mapping

Import COM Mapping and **Export COM Mapping** are used to save and load the COM mappings for the Select **Import COM Mapping** in the **COM Mapping** context menu to load settings into the selected module from an exported file; select **Export COM mapping** to save the current settings for the selected module to a text file. Note that this menu may also be opened by right-clicking **COM Mapping** in the navigation panel or by right-clicking the desired module.

IP Address Report Functions

IP Address Report functions are used to view IP address reports from appropriately configured modules. When monitoring is activated, Network Enabler Administrator listens for IP address reports on a UDP port number, which may be configured under **Settings** in the **IP Address Report** context menu. Any IP address reports received at this port number will be displayed in the window.

Select **Go** to begin monitoring for IP address reports, **Stop** to cease monitoring, and **Clear** to clear the current display of reports.

Note that in order for a PC running Network Enabler Administrator to receive IP address reports from a module, the module must set the PC's IP address as the destination. In addition, the module and the PC's designated port number for IP address reports should match. Please refer to the Network Settings section in Chapter 6 for additional information on configuring a module to send IP address reports.

Linux and UNIX Configuration

NE-4100 Series modules can be configured to work with Linux and UNIX operating systems. Drivers are included on the CD that comes with the module.

This chapter includes the following sections:

- ❑ **Linux Real TTY Drivers**
 - Basic Procedures
 - Hardware Setup
 - Installing Linux Real TTY Driver Files
 - Mapping TTY Ports
 - Removing Mapped TTY Ports
 - Removing Linux Driver Files
- ❑ **UNIX Fixed TTY Driver**
 - Installing the UNIX Driver
 - Configuring the UNIX Driver

Linux Real TTY Drivers

Basic Procedures

The basic procedures to map a Linux host's tty port to the module's serial port are as follows:

1. Set up the module. After verifying that the IP configuration works and you can access the module (by using ping, telnet, etc.), configure the module's serial port to Real COM mode.
2. Install the Linux Real tty driver files on the host
3. 3. Map the module's serial port to the host's tty port

Hardware Setup

Before proceeding with the software installation, make sure you have completed the hardware installation. Note that the module's default IP address is **192.168.127.254**.



ATTENTION

After installing the hardware, be sure that the module's serial port is configured to Real COM mode. This can be done with the web console, Telnet console, serial console, or Network Enabler Administrator.

Installing Linux Real TTY Driver Files

The instructions for installing the Linux Real TTY drivers are as follows:

1. Obtain the driver file from the included CD-ROM or from <http://www.moxa.com>.
2. Log in to the console as a super user (root).
3. Execute **cd /** to go to the root directory.
4. Copy the driver file **npreal2xx.tgz** to the / directory.
5. Execute **tar xvfz npreal2xx.tgz** to extract all files into the system.
6. Execute **/tmp/moxa/mxinst**.

For Red Hat AS/ES/WS and Fedora Core1, append an extra argument as follows:

/tmp/moxa/mxinst SP1

7. The shell script will install the driver files automatically. After the files are installed, you will be able to see several files in the /usr/lib/npreal2/driver folder:
 - > **mxaddsvr** (Add Server, mapping tty port)
 - > **mxdelsvr** (Delete Server, un-mapping tty port)
 - > **mxloadsvr** (Reload Server)
 - > **mxmknod** (Create device node/tty port)
 - > **mxrmnod** (Remove device node/tty port)
 - > **mxuninst** (Remove tty port and driver files)

At this point, you will be ready to map the system's tty port to the module's serial port.

Mapping TTY Ports

Make sure that you set the operation mode of the module's serial port to Real COM mode. After logging in as a super user, enter the directory `/usr/lib/npreal2/driver` and then execute `mxaddsvr` to map the module's serial port to the host tty ports. The syntax of `mxaddsvr` is as follows:

```
mxaddsvr [Module's IP Address] [Total Ports] ([Data port] [Cmd port])
```

The `mxaddsvr` command performs the following actions:

1. Modifies `npreal2d.cf`.
2. Creates tty ports in directory `/dev` with major & minor number configured in `npreal2d.cf`.
3. Restarts the driver.

Mapping tty ports automatically

To map tty ports automatically, you may execute `mxaddsvr` with just the IP address and number of ports, as in the following example:

```
# cd /usr/lib/npreal2/driver
# ./mxaddsvr 192.168.3.4 16
```

In this example, 16 tty ports will be added, all with IP 192.168.3.4, with data ports from 950 to 965 and command ports from 966 to 981.

Mapping tty ports manually

To map tty ports manually, you may execute `mxaddsvr` and manually specify the data and command ports, as in the following example:

```
# cd /usr/lib/npreal2/driver
# ./mxaddsvr 192.168.3.4 16 4001 966
```

In this example, 16 tty ports will be added, all with IP 192.168.3.4, with data ports from 4001 to 4016 and command ports from 966 to 981.

Removing Mapped TTY Ports

After logging in as root, enter the directory `/usr/lib/npreal2/driver` and then execute `mxdelsvr` to delete a server. The syntax of `mxdelsvr` is:

```
mxdelsvr [IP Address]
```

Example:

```
# cd /usr/lib/npreal2/driver
# ./mxdelsvr 192.168.3.4
```

The following actions are performed when executing `mxdelsvr`:

1. Modify `npreal2d.cf`.
2. Remove the relevant tty ports in directory `/dev`.
3. Restart the driver.

If the IP address is not provided in the command line, the program will list the installed servers and total ports on the screen. You will need to choose a server from the list for deletion.

Removing Linux Driver Files

A utility is included that will remove all driver files, mapped tty ports, and unload the driver. To do this, you only need to enter the directory `/usr/lib/npreal2/driver`, and then execute `mxuninst` to uninstall the driver. This program will perform the following actions:

1. Unload the driver.
2. Delete all files and directories in `/usr/lib/npreal2`
3. Delete directory `/usr/lib/npreal2`
4. Modify the system initializing script file.

UNIX Fixed TTY Driver

Installing the UNIX Driver

The instructions for installing the UNIX driver are as follows:

1. Log in to UNIX and create a directory for the Moxa TTY. To create a directory named `/usr/etc`, execute the command:

```
# mkdir -p /usr/etc
```
2. Copy `moxattyd.tar` to the directory you created. If you created the `/usr/etc` directory above, you would execute the following commands:

```
# cp moxattyd.tar /usr/etc
# cd /usr/etc
```
3. Extract the source files from the tar file by executing the command:

```
# tar xvf moxattyd.tar
```

The following files will be extracted:

```
README.TXT
moxattyd.c      --- source code
moxattyd.cf     --- an empty configuration file
Makefile        --- makefile
VERSION.TXT    --- fixed tty driver version
FAQ.TXT
```

4. Compile and Link

For SCO UNIX:

```
# make sco
```

For UnixWare 7:

```
# make svr5
```

For UnixWare 2.1.x, SVR4.2:

```
# make svr42
```

Configuring the UNIX Driver

Modify the configuration

The configuration used by the **moxattyd** program is defined in the text file **moxattyd.cf**, which is in the same directory that contains the program **moxattyd**. You may use **vi**, or any text editor to modify the file, as follows:

```
ttyp1 192.168.1.1 950
```

For more configuration information, view the file **moxattyd.cf**, which contains detailed descriptions of the various configuration parameters.



ATTENTION

The Device Name depends on the OS. See the Device Naming Rule section in README.TXT for more information.

To start the **moxattyd** daemon after system bootup, add an entry into **/etc/inittab**, with the tty name you configured in **moxattyd.cf**, as in the following example:

```
ts:2:respawn:/usr/etc/moxattyd/moxattyd -t 1
```

Device naming rule

For UnixWare 7, UnixWare 2.1.x, and SVR4.2, use:

```
pts/[n]
```

For all other UNIX operating systems, use:

```
ttyp[n]
```

Starting moxattyd

Execute the command **init q** or reboot your UNIX operating system.

Adding an additional server

1. Modify the text file **moxattyd.cf** to add an additional server. User may use **vi** or any text editor to modify the file. For more configuration information, look at the file **moxattyd.cf**, which contains detailed descriptions of the various configuration parameters.
2. Find the process ID (PID) of the program **moxattyd**.

```
# ps -ef I grep moxattyd
```
3. Update the configuration of **moxattyd** program.

```
# kill -USR1 [PID]
```

(e.g., if **moxattyd** PID = 404, **kill -USR1 404**)

This completes the process of adding an additional server

Serial Command Mode

Serial command mode allows configuration of the module through serial commands received directly through the serial port. It is available on NE-4100 Series modules with firmware version 3.0 and above

This chapter includes the following sections:

- ❑ **Overview**
- ❑ **Serial Command Format and Command Set**
 - Command Structure
 - Reply Structure
 - OP Codes and Parameters
- ❑ **Operation Flow Chart**
- ❑ **Configuring Trigger Type**
 - Network Enabler Administrator
 - Telnet Console
 - Web Console
 - Serial Console
- ❑ **Entering Serial Command Mode**
 - Trigger Type
 - Serial Port Parameters
 - Comments
- ❑ **Exiting Serial Command Mode**
- ❑ **Determining the Active Mode**
- ❑ **Serial Command Examples**
 - Example 1: Get Model Name Using HW Trigger
 - Example 2: Change IP Address Using HW Trigger
 - Example 3: Get IP Mode Using SW Trigger
 - Example 4: Change TCP Port Number Using SW Trigger

Overview

Serial command mode allows the module's parameters to be retrieved or configured through the serial port, rather than through the console port or over the network. This is done through the use of specially parsed commands sent to the module through the serial port. Device manufacturers can take advantage of serial command mode to add local configuration capability to their products. For example, card reader manufacturers can use the card reader's number pad to configure serial and network settings such as IP address, netmask, and baud rate. Serial command mode thus allows on-site configuration of devices without requiring a laptop or other additional equipment.

Serial command mode is built into firmware version 3.0 and above.

Serial Command Format and Command Set

Each command and reply is a sequence of case-sensitive ASCII characters transmitted in the following order: Head, Command Code, OP Code, Parameter, and Tail.



ATTENTION

The **carriage return** character is used as the last byte or Tail for each data frame; an additional **line feed** character is not required. For most systems, the Enter key typically sends a carriage return character and a line feed character. *CR* is used to refer to the carriage return character in most terminal emulators and in this manual, *LF* is used to refer to the line feed character. In hex, *CR* is 0x0D and *LF* is 0x0A. In C language, “\r” refers to *CR*, whereas “\n” refers to *CR* + *LF*.

Command Structure

Descriptor	Bytes	Character	Description
C-Head	1	“>”	fixed value (0x3E)
Command Code	1	“R”, “W”	R: get module parameter W: set module parameter
OP Code	2	(varies)	
Parameter	varies	(varies)	
Tail	1	<i>CR</i>	carriage return character, no line feed

For example, the following sequence of characters will instruct the module to change the TCP server port number to 4001:

“>WTL4001” + *CR*

Available OP Codes and Parameters are described in detail later in this chapter.

Reply Structure

Descriptor	Bytes	Character	Description
R-Head	1	"<"	fixed value (0x3C)
Reply Code	1	"Y", "1" to "5", "E"	Y: command was executed successfully 1: command not supported 2: OP code not supported 3: invalid command encapsulation 4: invalid parameter 5: invalid return value E: enter serial command mode
OP Code	2	(varies)	
Parameter	varies	(varies)	
Tail	1	CR	carriage return character, no line feed

For example, the following sequence of characters means that the TCP server port number has been written successfully:

"<YTL"+ CR

Available OP Codes and Parameters are described in the next section.

OP Codes and Parameters

Basic Commands

OP Code	Parameter	Comments
BS	(read only)	serial number
BV	(read only)	firmware version
BN	(alphanumeric, max. 15 bytes)	server name
BW	0: disable 1: enable	web console
BT	0: disable 1: enable	Telnet console
BP	(alphanumeric, max. 10 bytes)	password
BR	1: restart only 2: save & restart (write only)	save and restart
NC	0: static 1: DHCP	IP configuration
NP	xxx.xxx.xxx.xxx (e.g., 192.168.127.254)	IP address
NM	xxx.xxx.xxx.xxx (e.g., 255.255.0.0)	netmask
NG	xxx.xxx.xxx.xxx (e.g., 192.168.1.254)	gateway
NA	(read only) (e.g., 00:90:e8:09:44:fe)	MAC address

Accessible IF

OP Code	Parameter	Comments
AS	0: disable 1: enable	accessible IP list filtering
AA	xxx.xxx.xxx.xxx (e.g., 192.168.127.1)	accessible IP address 01
AB	xxx.xxx.xxx.xxx (e.g., 192.168.127.1)	accessible IP address 02
AC	xxx.xxx.xxx.xxx (e.g., 192.168.127.1)	accessible IP address 03
AD	xxx.xxx.xxx.xxx (e.g., 192.168.127.1)	accessible IP address 04
AE	xxx.xxx.xxx.xxx (e.g., 192.168.127.1)	accessible IP address 05
AF	xxx.xxx.xxx.xxx (e.g., 192.168.127.1)	accessible IP address 06
AG	xxx.xxx.xxx.xxx (e.g., 192.168.127.1)	accessible IP address 07
AH	xxx.xxx.xxx.xxx (e.g., 192.168.127.1)	accessible IP address 08
AI	xxx.xxx.xxx.xxx (e.g., 192.168.127.1)	accessible IP address 09
AJ	xxx.xxx.xxx.xxx (e.g., 192.168.127.1)	accessible IP address 10
AK	xxx.xxx.xxx.xxx (e.g., 192.168.127.1)	accessible IP address 11
AL	xxx.xxx.xxx.xxx (e.g., 192.168.127.1)	accessible IP address 12
AM	xxx.xxx.xxx.xxx (e.g., 192.168.127.1)	accessible IP address 13
AN	xxx.xxx.xxx.xxx (e.g., 192.168.127.1)	accessible IP address 14
AO	xxx.xxx.xxx.xxx (e.g., 192.168.127.1)	accessible IP address 15
AP	xxx.xxx.xxx.xxx (e.g., 192.168.127.1)	accessible IP address 16
Aa	xxx.xxx.xxx.xxx (e.g., 255.255.255.0)	accessible IP netmask 01
Ab	xxx.xxx.xxx.xxx (e.g., 255.255.255.0)	accessible IP netmask 02
Ac	xxx.xxx.xxx.xxx (e.g., 255.255.255.0)	accessible IP netmask 03
Ad	xxx.xxx.xxx.xxx (e.g., 255.255.255.0)	accessible IP netmask 04
Ae	xxx.xxx.xxx.xxx (e.g., 255.255.255.0)	accessible IP netmask 05

OP Code	Parameter	Comments
Af	xxx.xxx.xxx.xxx (e.g., 255.255.255.0)	accessible IP netmask 06
Ag	xxx.xxx.xxx.xxx (e.g., 255.255.255.0)	accessible IP netmask 07
Ah	xxx.xxx.xxx.xxx (e.g., 255.255.255.0)	accessible IP netmask 08
Ai	xxx.xxx.xxx.xxx (e.g., 255.255.255.0)	accessible IP netmask 09
Aj	xxx.xxx.xxx.xxx (e.g., 255.255.255.0)	accessible IP netmask 10
Ak	xxx.xxx.xxx.xxx (e.g., 255.255.255.0)	accessible IP netmask 11
Al	xxx.xxx.xxx.xxx (e.g., 255.255.255.0)	accessible IP netmask 12
Am	xxx.xxx.xxx.xxx (e.g., 255.255.255.0)	accessible IP netmask 13
An	xxx.xxx.xxx.xxx (e.g., 255.255.255.0)	accessible IP netmask 14
Ao	xxx.xxx.xxx.xxx (e.g., 255.255.255.0)	accessible IP netmask 15
Ap	xxx.xxx.xxx.xxx (e.g., 255.255.255.0)	accessible IP netmask 16

Operation Mode

OP Code	Parameter	Comments
OM	0: Real COM 1: TCP server 2: TCP client 3: UDP mode	operation mode

TCP Server Mode

OP Code	Parameter	Comments
TM	1 – 4	max. number of connections
TL	0 – 65535	local TCP port
TT	0 – 99 (minutes)	TCP alive check time
TI	0 – 65535 (ms)	inactivity time
TX	0: no delimiter 1: enable 1-character delimiter 2: enable 2 character delimiter	number of characters to use as delimiter
TY	ASCII character in hex code (i.e., "A1" for character 0xA1)	character to use for delimiter 1
TZ	ASCII character in hex code (i.e., "A1" for character 0xA1)	character to use for delimiter 2
TF	0 – 65535 (ms)	force transmit time

Real COM Mode

OP Code	Parameter	Comments
RM	1 – 4	max. number of connections
RT	0 – 99 (minutes)	TCP alive check time
RX	0: no delimiter 1:enable 1-character delimiter 2:enable 2 character delimiter	number of characters to use as delimiter
RY	ASCII character in hex code (i.e., "A1" for character 0xA1)	character to use for delimiter 1
RZ	ASCII character in hex code (i.e., "A1" for character 0xA1)	character to use for delimiter 2
RF	0 – 65535 (ms)	force transmit time

TCP Client Mode

OP Code	Parameter	Comments
CM	0: startup 1: any character	TCP connect on
CA	xxx.xxx.xxx.xxx (e.g., 192.168.1.1)	destination IP address 1
CB	xxx.xxx.xxx.xxx (e.g., 192.168.1.1)	destination IP address 2
CC	xxx.xxx.xxx.xxx (e.g., 192.168.1.1)	destination IP address 3
CD	xxx.xxx.xxx.xxx (e.g., 192.168.1.1)	destination IP address 4
C1	0 – 65535	destination port 1
C2	0 – 65535	destination port 2
C3	0 – 65535	destination port 3
C4	0 – 65535	destination port 4
CT	0 – 99 (minutes)	TCP alive check time
CI	0 – 65535 (ms)	inactivity time
CX	0: no delimiter 1: enable 1-character delimiter 2: enable 2 character delimiter	number of characters to use as delimiter
CY	ASCII character in hex code (i.e., "A1" for character 0xA1)	character to use for delimiter 1
CZ	ASCII character in hex code (i.e., "A1" for character 0xA1)	character to use for delimiter 2
CF	0 – 65535 (ms)	force transmit time

UDP Mode

OP Code	Parameter	Comments
UL	0 – 65535	local listen port
UA	xxx.xxx.xxx.xxx (e.g., 192.168.1.1)	destination IP address 1, begin range

OP Code	Parameter	Comments
UB	xxx.xxx.xxx.xxx (e.g., 192.168.1.1)	destination IP address 2, begin range
UC	xxx.xxx.xxx.xxx (e.g., 192.168.1.1)	destination IP address 3, begin range
UD	xxx.xxx.xxx.xxx (e.g., 192.168.1.1)	destination IP address 4, begin range
Ua	xxx.xxx.xxx.xxx (e.g., 192.168.1.1)	destination IP address 1, end range
Ub	xxx.xxx.xxx.xxx (e.g., 192.168.1.1)	destination IP address 2, end range
Uc	xxx.xxx.xxx.xxx (e.g., 192.168.1.1)	destination IP address 3, end range
Ud	xxx.xxx.xxx.xxx (e.g., 192.168.1.1)	destination IP address 4, end range
U1	0 – 65535	destination IP address 1, port
U2	0 – 65535	destination IP address 2, port
U3	0 – 65535	destination IP address 3, port
U4	0 – 65535	destination IP address 4, port
UX	0: no delimiter 1: enable 1-character delimiter 2: enable 2 character delimiter	number of characters to use as delimiter
UY	ASCII character in hex code (i.e., "A1" for character 0xA1)	character to use for delimiter 1
UZ	ASCII character in hex code (i.e., "A1" for character 0xA1)	character to use for delimiter 2
UF	0 – 65535 (ms)	force transmit time

Digital IO

OP Code	Parameter	Comments
DM	bytes 1 and 2 (DIO #) 00: DIO 0 01: DIO 1 02: DIO 2 03: DIO 3 byte 3 (DIO mode) 0: input 1: output	set DIO mode (e.g., "000" sets DIO 0 to input mode)
DS	bytes 1 and 2 (DIO #) 00: DIO 0 01: DIO 1 02: DIO 2 03: DIO 3 byte 3 (DIO status) 0: low 1: high	set DIO status (e.g., "011" sets DIO 1 to high)

Serial Command Mode

OP Code	Parameter	Comments
ES	0: disable 1: enable HW trigger 2: enable SW trigger	enable serial command mode
EC	three ASCII characters in hex code (i.e., "A1A2A3" for ASCII characters 0xA1, 0xA2, 0xA3)	SW trigger characters

Operation Flow Chart

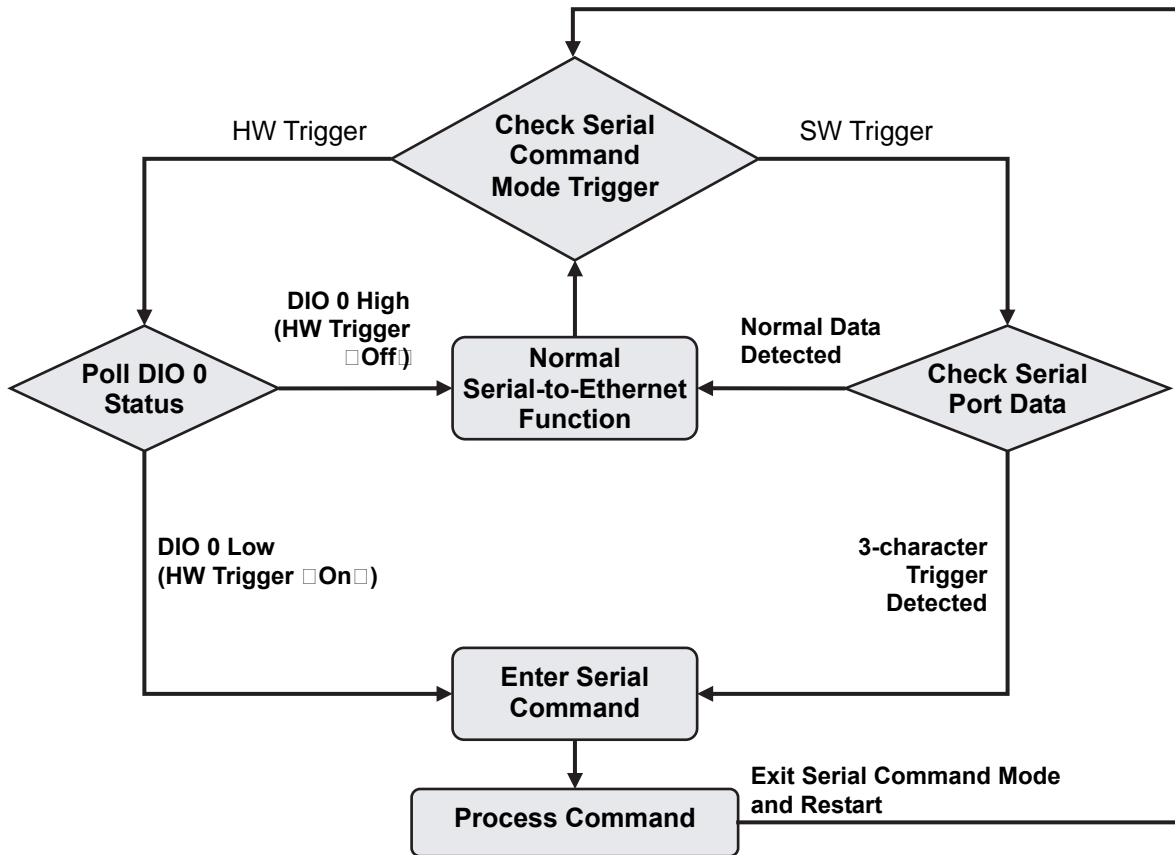

ATTENTION

This flowchart represents a continual process. You can start trace out a logical flow by starting anywhere on the chart.

Diamonds represent decision points. Only one path leading out of any diamond can be followed.

Configuring Trigger Type

Serial command mode may be triggered by either software or hardware. Initially, you may use one of the following configuration tools to set the trigger type: Network Enabler Administrator, Telnet console, web console, or serial console.

The hardware trigger involves using DIO 0 to enter serial command mode. The software trigger involves using a three-character sequence sent to the serial port to enter serial command mode. For hardware versions 1.1 or earlier, when the SW Trigger is enabled, the highest achievable data transmission rate will be reduced from 234000 bps to 55000 bps. This is because all data received through serial port 0 will be parsed. In other words, the system must continuously check the serial port data for the SW Trigger characters. This is not an issue for hardware versions 2.1 and later.

Network Enabler Administrator

To use Network Enabler Administrator to configure the trigger type, you will need to find the module and open its configuration window. Please refer to Chapter 7 for additional details.

The trigger type will be configured under the **Serial CMD** tab. Check the **Modify** box in order to make changes to the settings. **Enable** must be checked in order to configure the trigger type.

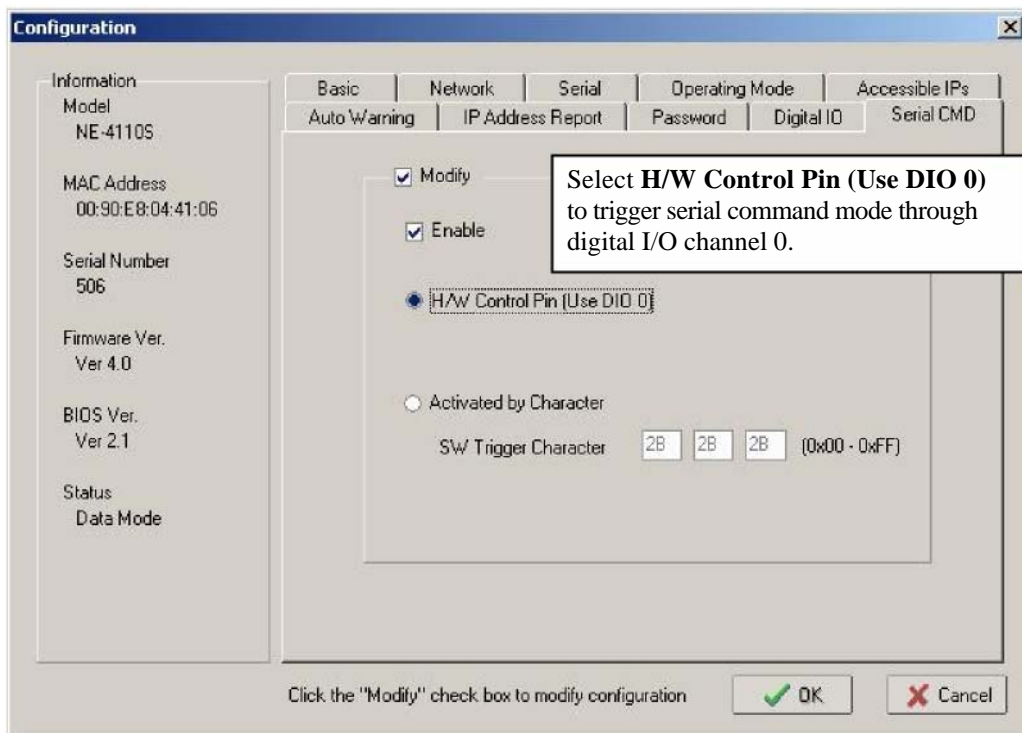

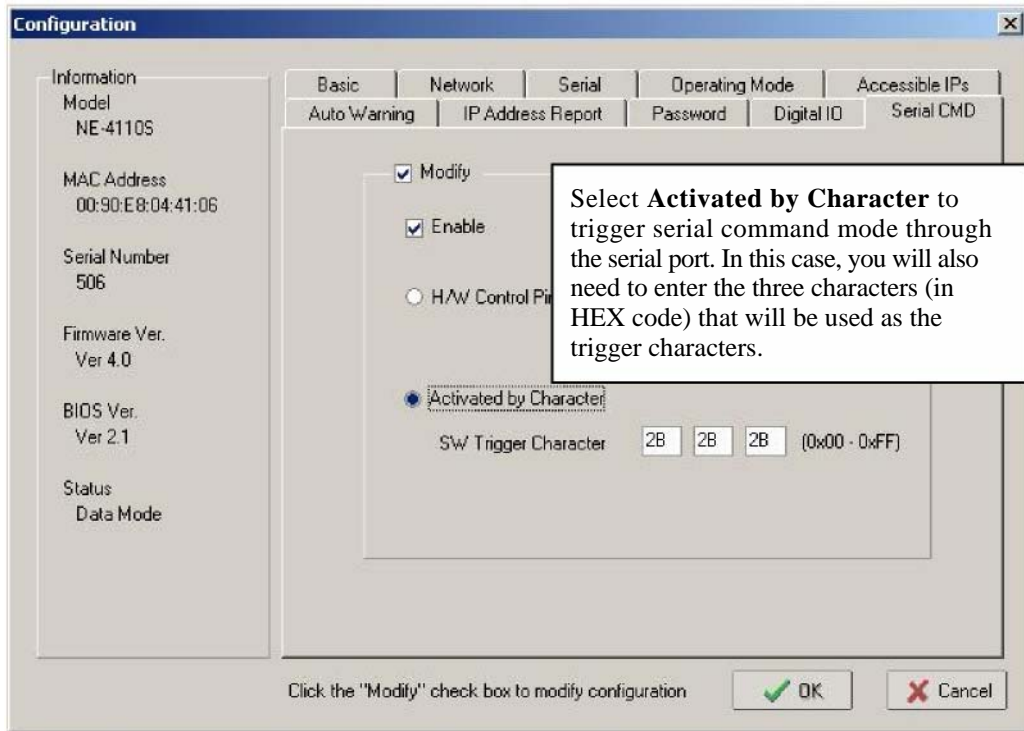

When the trigger has been configured, click **OK** to save and restart the module with the new settings.



ATTENTION

The default setting is HW Trigger Enabled. Only one type of trigger may be selected; hardware and software trigger may not be used at the same time.

Telnet Console

Please refer to Chapter 5 for information on opening the Telnet console.

```
ORA Telnet 192.168.127.254
-----
Model name       : NE-4100T
MAC address      : 00:90:E8:09:5C:F0
Serial No       : 44
Firmware version : 3.2
-----
<< Main Menu >>
<1> Basic settings
<2> Network settings
<3> Serial settings
<4> DIO setting
<5> Serial Command Mode setting
<6> Operating settings
<7> Accessible IP settings
<8> Auto warning settings
<9> Monitor
<a> Ping
<b> Change password
<c> Load factory default
<v> View settings
<s> Save/Restart
<q> Quit

Key in your selection:
```

Press **5** and the **Enter** key to select **Serial Command Mode setting**.

```
ORA Telnet 192.168.127.254
Key in your selection: 5
-----
<< Main Menu->Serial Command Mode setting >>
<1> HW/SW Trigger Setting
<2> SW Trigger Character
<m> Back to main menu
<q> Quit
```

From the **Serial Command Mode setting** menu, select **1** in order to select and enable the trigger type (hardware or software). If software triggering is selected, the three trigger characters may be configured using option **2**. For the changes to take effect, you will need to go back to the main menu, save the configuration, and restart the module. If you quit without saving, any changes you made to the configuration will be lost.

Web Console

Please refer to Chapter 6 for information on opening the web console. Click on the **Serial Command Mode** folder in the navigation panel.

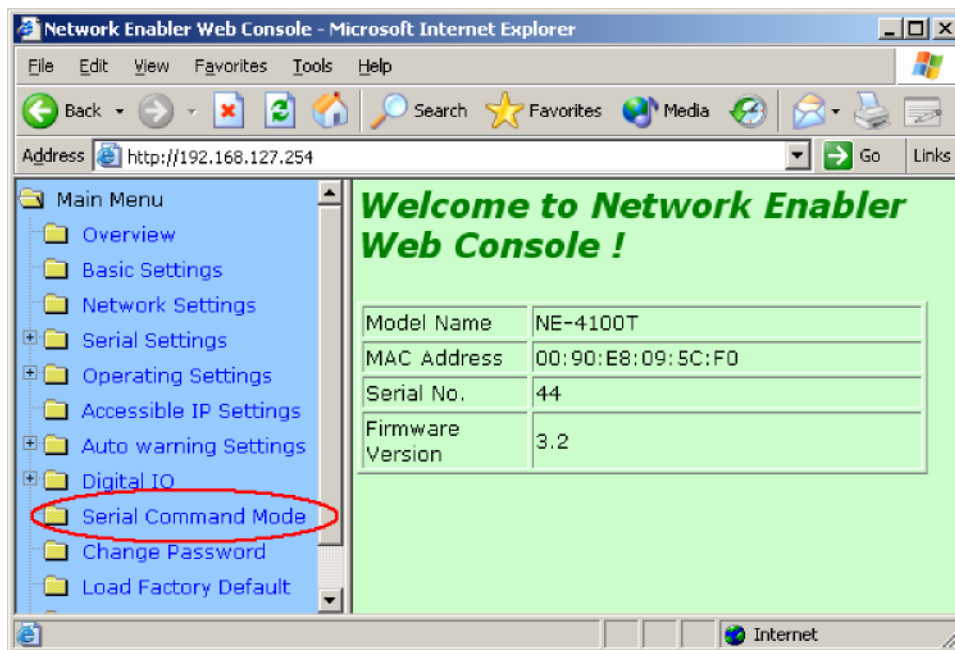

Modify the settings as needed, and then click on **Submit**. Remember that you will need to save the configuration and restart the module for any changes to effect.

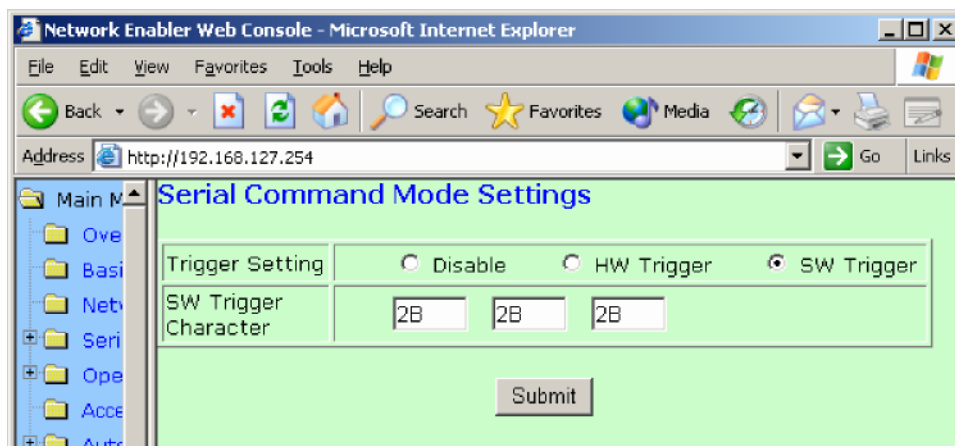

Serial Console

To access the serial console, connect the module's serial console port (P1) to your PC's serial port, and then use a terminal emulator program to enter the serial console. Please refer to the Serial Console section in Chapter 5 for details on how to open the serial console. Once the serial console is open, it functions exactly the same as if connecting by Telnet console.

Entering Serial Command Mode

Trigger Type

The module can enter serial command mode through either a hardware trigger or a software trigger, depending on how it has been configured. Please refer to the previous section for details on how to configure the trigger type.

Hardware Trigger

- Set up a hardware trigger with the DIO 0 channel.
- Use the trigger to pull DIO 0 to **low** in order to enter serial command mode. **Low** state must be maintained for at least 200 ms to qualify as a valid trigger.

Software Trigger

- Define 3 characters as the software trigger.
- Send the 3 trigger characters to the serial port in rapid sequence (the characters should be separated by less than 80 ms) to enter serial command mode. We guarantee that when characters are spaced by more than 120 ms, the data will be treated as normal data, instead of serial command mode trigger characters. When characters are separated by between 80 ms and 120 ms, the system will not be able to determine if the transmission is regular data, or a serial command mode trigger.

Serial Port Parameters

For testing purposes, you will likely use a terminal emulator to send and receive data frames in serial command mode. The module's serial parameters may be obtained from Network Enabler Administrator, or from the web or Telnet consoles. For example, from Network Enabler Administrator, the settings may be found in the **Configuration** functions by selecting **Configure** and then selecting the **Serial** tab. After selecting the module's serial port, click on **Settings** to open the **Serial Settings** window.

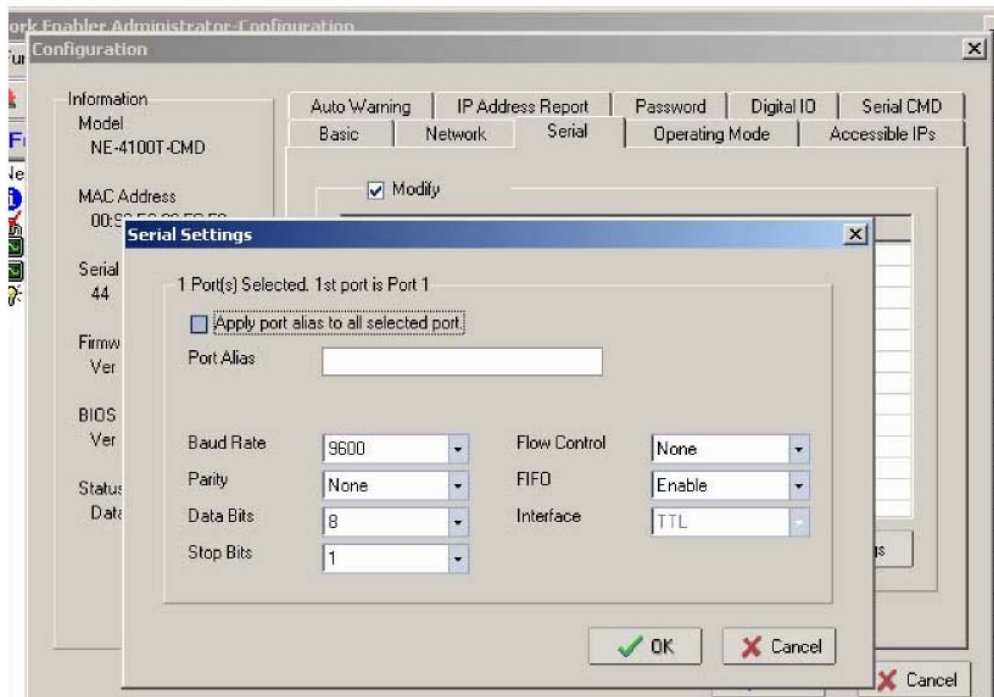

**ATTENTION**

Note that using a software trigger to enable Serial Command Mode may fail if the baudrate you are using is too small. For example, using a baudrate of 110 could cause the trigger to fail.

Comments

When first entering serial command mode, the module will respond with the string “<E” + CR. All data communication will cease when the device is in serial command mode.

- Any open TCP connection will be closed, for both the client and the server.
- No new TCP connections will be allowed.
- UDP data communication will be disabled.

Exiting Serial Command Mode

After the module has entered serial command mode, there are three ways to exit.

- **Power Off**

If the module is powered off without saving the configuration, all changes will be lost when the module is powered on again.

- **Exit by Command (OP Code: BR)**

There are two options when manually exiting by serial command. **Save & Restart** must be selected if you want to save any of the changes that were made during the serial command mode session. **Restart** will restart the module without saving any of the changes.

- **Auto Restart**

If 5 minutes elapses without inputting a valid command, then the module will automatically restart without saving the configuration.

Determining the Active Mode

If you need to verify whether or not the module is operating in serial command mode, there are two methods available: by Network Enabler Administrator or by serial console. In Network Enabler Administrator, you may open a module's configuration window and determine if it is in serial command mode in the Information panel.

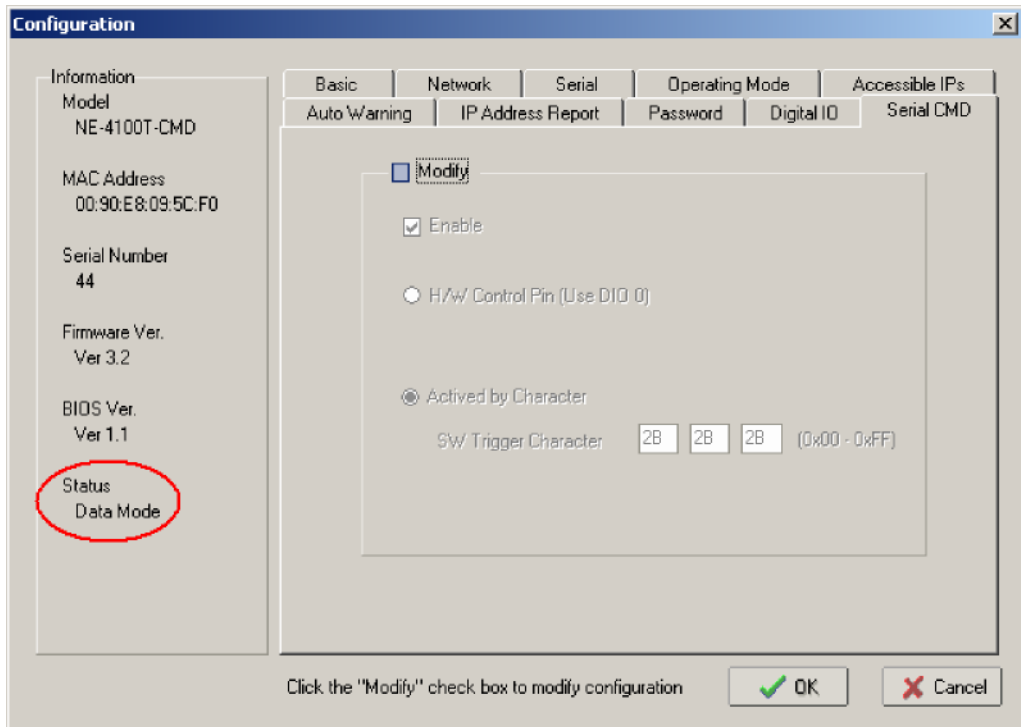

In the example above, the status is **Data Mode**, which indicates normal data transmission. For serial command mode, the status would be **Command Mode**.

You may also verify if the module is in serial command mode by attaching a serial console to the serial port (P0). If the module is in serial command mode, it will respond with a sequence of characters after receiving the serial command end character CR, as shown below.

Command sent by serial device	Module's reply
CR	"<E" + CR (0x3C, 0x45, 0x0D)
CR + LF (0x0D, 0x0A)	"<E" + CR (0x3C, 0x45, 0x0D)
Error command	"<3" + CR (0x3C, 0x33, 0x0D)

Therefore, you can determine if a module is in serial command mode by sending CR to the module seeing if the module replies with "<E" + CR.

Serial Command Examples

For the following examples, the module should be installed onto the evaluation board, and the evaluation board's serial port (P0) should be connected to a COM port on your PC.



ATTENTION

When using a terminal emulator program such as PComm Terminal, make sure that the Enter key is configured to send CR only, rather than CR + LF.

Example 1: Get Model Name Using HW Trigger

- STEP 1. Verify that the hardware trigger is enabled for serial command mode.
- STEP 2. Check the module's serial port settings.
- STEP 3. Start Windows HyperTerminal and make sure that the PC's serial port settings match the module's settings.
- STEP 4. Pull DIO 0 to "Low" to enter serial command mode. DIP switch 0 on the evaluation board may be used to control DIO 0's state. Please refer to Chapter 3 for information on configuring the DIP switches for use with DIO channels.
- STEP 5. HyperTerminal displays "<E", indicating that the module is in serial command mode.
- STEP 6. Type ">RBN" in HyperTerminal and press Enter, which requests the module's model name.
- STEP 7. HyperTerminal displays "<YBNNE-4100T", indicating that the module's model name is "NE-4100T".
- STEP 8. Type ">WBR1" in HyperTerminal and press Enter, which exits serial command mode.

Example 2: Change IP Address Using HW Trigger

- STEP 1. Verify that the hardware trigger is enabled for serial command mode.
- STEP 2. Check the module's serial port settings.
- STEP 3. Start Windows HyperTerminal and make sure that the PC's serial port settings match the module's settings.
- STEP 4. Pull DIO 0 to "Low" to enter serial command mode. DIP switch 0 on the evaluation board may be used to control DIO 0's state. Please refer to Chapter 3 for information on configuring the DIP switches for use with DIO channels.
- STEP 5. HyperTerminal displays "<E", indicating that the module is in serial command mode.
- STEP 6. Type ">WNP192.168.127.253" in HyperTerminal and press Enter, which sets the module's IP address to 192.168.127.253.
- STEP 7. HyperTerminal displays "<YNP", indicating that the IP address command was executed successfully.
- STEP 8. Type ">WBR2" in HyperTerminal and press Enter, which saves changes and restarts the module.
- STEP 9. Repeat STEP 1 to STEP 5 to re-enter serial command mode.
- STEP 10. Type ">RNP" in HyperTerminal and press Enter, which requests the module's IP address.
- STEP 11. HyperTerminal displays "<YNP192.168.127.253", indicating that the module's IP address is 192.168.127.253.
- STEP 12. Type ">WBR1" in HyperTerminal and press Enter, which exits serial command mode.

Example 3: Get IP Mode Using SW Trigger

- STEP 1. Verify that the software trigger is enabled for serial command mode, and check the three trigger characters. For this example, assume the trigger is "2B 2B 2B".
- STEP 2. Check the module's serial port settings.
- STEP 3. Start Windows HyperTerminal and make sure that the PC's serial port settings match the module's settings.
- STEP 4. Type the three trigger characters used to enter serial command mode; "2B 2B 2B" in this example.
- STEP 5. HyperTerminal displays "<E", indicating that the module is in serial command mode.

- STEP 6. Type ">**RNC**" in HyperTerminal and press Enter, which requests the module's IP mode.
- STEP 7. HyperTerminal displays "<**YNC1**", indicating that the module's IP mode is DHCP.
- STEP 8. Type ">**WBR1**" in HyperTerminal and press Enter, which exits serial command mode.

Example 4: Change TCP Port Number Using SW Trigger

- STEP 1. Verify that the software trigger is enabled for serial command mode, and check the three trigger characters. For this example, assume the trigger is "2B 2B 2B".
- STEP 2. Check the module's serial port settings.
- STEP 3. Start Windows HyperTerminal and make sure that the PC's serial port settings match the module's settings.
- STEP 4. Type the three trigger characters used to enter serial command mode; "2B 2B 2B" in this example.
- STEP 5. HyperTerminal displays "<**E**", indicating that the module is in serial command mode.
- STEP 6. Type ">**WTL4001**" in HyperTerminal and press Enter, which sets the TCP server port number to 4001.
- STEP 7. HyperTerminal displays "<**YTL**", indicating that the TCP server port command was executed successfully.
- STEP 8. Type ">**WBR2**" in HyperTerminal and press Enter, which saves all changes and restarts the module.
- STEP 9. Repeat STEP 1 to STEP 5 to re-enter serial command mode.
- STEP 10. Type ">**RTL**" in HyperTerminal and press Enter, which requests the TCP server's TCP port number.
- STEP 11. HyperTerminal displays "<**YTL4001**", indicating that the TCP server's TCP port number is 4001.
- STEP 12. Type ">**WBR1**" in HyperTerminal and press Enter, which exits serial command mode.

A

Well Known Port Numbers

This appendix is included for your reference. Listed below are port numbers that already have a well-established use. These port numbers should be avoided when assigning a port number to your NE-4100 Series module; otherwise you may experience network problems. Refer to the RFC 1700 standard for Well Known Port Numbers or refer to the following introduction from IANA.

The port numbers are divided into three ranges: the Well Known Ports, the Registered Ports, and the Dynamic and/or Private Ports.

The Well Known Ports are those from 0 through 1023.

The Registered Ports are those from 1024 through 49151.

The Dynamic and/or Private Ports are those from 49152 through 65535.

The Well Known Ports are assigned by IANA, and on most systems, can only be used by system processes or by programs executed by privileged users. The following table shows famous port numbers among the well-known port numbers. For more details, please visit the IANA website at <http://www.iana.org/assignments/port-numbers>.

TCP Socket	Application Service
0	reserved
1	TCP Port Service Multiplexor
2	Management Utility
7	Echo
9	Discard
11	Active Users (systat)
13	Daytime
15	Netstat
20	FTP data port
21	FTP CONTROL port
23	Telnet
25	SMTP (Simple Mail Transfer Protocol)
37	Time (Time Server)
42	Host name server (names server)
43	Whois (nickname)
49	(Login Host Protocol) (Login)
53	Domain Name Server (domain)
79	Finger protocol (Finger)

TCP Socket	Application Service
80	World Wide Web HTTP
119	Network News Transfer Protocol (NNTP)
123	Network Time Protocol
213	IPX
160 – 223	Reserved for future use

UDP Socket	Application Service
0	reserved
2	Management Utility
7	Echo
9	Discard
11	Active Users (systat)
13	Daytime
35	Any private printer server
39	Resource Location Protocol
42	Host name server (names server)
43	Whois (nickname)
49	(Login Host Protocol) (Login)
53	Domain Name Server (domain)
69	Trivial Transfer Protocol (TFTP)
70	Gopher Protocol
79	Finger Protocol
80	World Wide Web HTTP
107	Remote Telnet Service
111	Sun Remote Procedure Call (Sunrpc)
119	Network news Transfer Protocol (NNTP)
123	Network Time protocol (ntp)
161	SNMP (Simple Network Mail Protocol)
162	SNMP Traps
213	IPX (Used for IP Tunneling)

B

NECI Library

NECI (Network Enabler Configuration Interface) is a set of APIs that run on Windows systems (95 and above) to search, locate, and configure NE-4100 Series modules over the network. The NE-4100 Series library can be found in the folder `.\NECI_LIB\` on the Documentation and Software CD included with each module. For more information, refer to **NECI.chm** in that directory as well as examples located in `.\NECI_LIB\VC\ConsoleExample`.

Auto IP Report Protocol

There are several ways to configure the IP address of an NE-4100 Series module. One of them is DHCP Client. When you set up the module to use DHCP Client for IP address configuration, it will automatically send a DHCP request over the network to find the DHCP server. The DHCP server will then send an available IP address to the module with an expiration time. The module will use this IP address until the expiration time has been reached. When the expiration time has been reached, the process will repeat, and module will send another DHCP request to the DHCP server. Therefore, a module may end up using more than one IP address while it is connected to the network.

The module has a built-in IP address report function that will send its IP data to a specific IP address and port number when it is not using a Static or fixed IP address. The IP address report parameters may be configured in the Network Settings in the web console. Enter the IP address and the port number of the PC that is to receive this information as shown below:

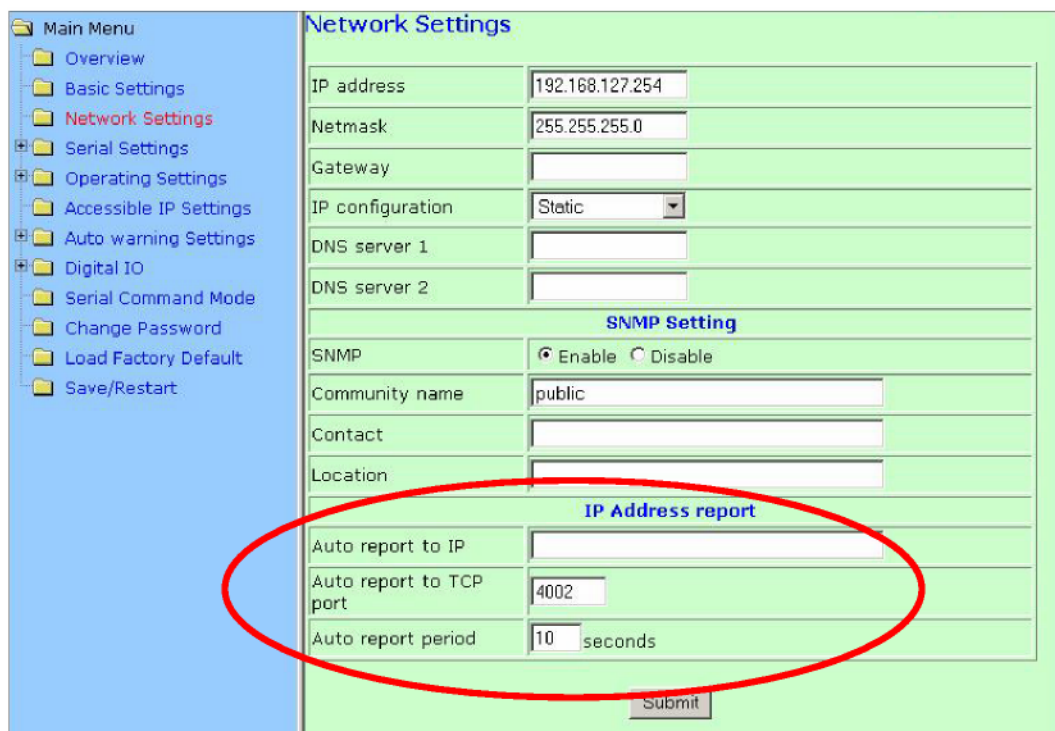

The screenshot displays the 'Network Settings' web console. On the left is a navigation menu with options like 'Main Menu', 'Overview', 'Basic Settings', 'Network Settings', 'Serial Settings', 'Operating Settings', 'Accessible IP Settings', 'Auto warning Settings', 'Digital IO', 'Serial Command Mode', 'Change Password', 'Load Factory Default', and 'Save/Restart'. The main content area is titled 'Network Settings' and contains several configuration sections. The 'IP Address report' section is circled in red and includes the following fields:

IP Address report	
Auto report to IP	<input type="text"/>
Auto report to TCP port	<input type="text" value="4002"/>
Auto report period	<input type="text" value="10"/> seconds

Below the 'IP Address report' section is a 'Submit' button. Other sections visible include 'SNMP Setting' with fields for 'SNMP' (radio buttons for 'Enable' and 'Disable'), 'Community name' (text input 'public'), 'Contact', and 'Location'. The 'Network Settings' section above includes fields for 'IP address' (192.168.127.254), 'Netmask' (255.255.255.0), 'Gateway', 'IP configuration' (Static), 'DNS server 1', and 'DNS server 2'.

IP Address Report Structure

The first 4 bytes of the module's IP address report are the characters "Moxa". The rest of the report is composed of 9 items, with each item preceded by a 2-byte header indicating the item ID and item length.

Header (Item ID)	Header, (Item Length)	Item
(none)	(none)	"Moxa" (text string)
1	(varies)	server name (text string)
2	2	hardware ID (little endian, see table below)
3	6	MAC address (00-90-E8-01-02-03 would be sent in sequence as 0x00, 0x90, 0xE8, 0x01, 0x02, 0x03)
4	4	serial number (little endian DWORD)
5	4	IP address
6	4	netmask
7	4	default gateway
8	4	firmware version (little endian DWORD, Version 4.3.1= 0x04030100)
9	4	AP ID (little endian DWORD, see table below)

Hardware and AP ID

Each model is assigned a Hardware ID and AP ID as shown below:

Product	Hardware ID	AP ID
NE-4110S	0x4119	0x80004100
NE-4120S	0x4129	0x80004100
NE-4100T	0x4109	0x80004100
NE-4110A	0x4118	0x80004100
NE-4120A	0x4128	0x80004100

Example

The following example shows the first 22 bytes of a typical IP address report:

	report header "Moxa"				item ID	item length	server name "TEST"				item ID	item length	hardware ID 0x4119		item ID	item length	MAC address 00-90-E8-01-02-03						
HEX	4D	4F	58	41	01	04	54	45	53	54	02	02	19	41	03	06	00	90	E8	01	02	03	
ASCII	"M"	"O"	"X"	"A"			"T"	"E"	"S"	"T"													

D

DIO Commands

In this appendix, we provide information on sending commands to the module's DIO channels over an Ethernet network. Digital I/O commands and responses are accessed using a specific TCP port (default 5001) on the module. Each command is initiated by the host and is followed by a response from the module. A utility on the CD-ROM can be used to test the DIO access commands.

Overview

Each DIO command and response consists of a 4-byte header and up to 255 bytes of data. The first byte of the header indicates the command. The second byte indicates the version, which is "2" for current firmware versions. The third byte is a code that is used by the module to report errors. The fourth byte is the number of bytes that follows the header, and will depend on the command or response.

In the event of an error, the module will return the entire command as its response, but with the third byte changed according to the following status/error codes:

- 1: Command error; may be unknown
- 2: Version error; not supported by this version
- 3: Length error; the length member does not match the attached data
- 4: Operation error; invalid status or invalid mode
- 5: "Packet too short" error
- 6: DIO number error; might not support request DIO number
- 0xFF: other unknown error



ATTENTION

DIO command data is transmitted as values rather than text strings. A value of 1 would be transmitted as 0x01.

C Code Example

```
//define DIO Header format
typedef struct _DIO_Header_Struct {
    char    command;
    char    version;        /* This specification is version 2 */
    char    status;
    char    length;
} DIOHeaderStruct, *pDIOHeaderStruct;
//define DIO Packet format
//Used for Command and ACK packet
typedef struct _DIO_Packet_Struct {
    DIOHeaderStruct header;
    Char    data[ 255];
} DIOPacketStruct, *pDIOPacketStruct;
```

Read Single DIO

Command

Byte #	Descriptor	Value	Description
1	Header	1	command #, fixed
2	Header	2	version, fixed
3	Header	(any)	this byte is only used in the module's response
4	Header	1	data length, fixed
5	Data	0, 1, 2, 3	desired DIO channel #

For example, the 5-byte command sequence **1-2-0-1-0** requests the status of DIO 0.

Response

Byte #	Descriptor	Value	Description
1	Header	1	command #, fixed
2	Header	2	version, fixed
3	Header	0, 1, 2, 3, 4, 5, 6, 0xFF	command status/error code (0 = okay)
4	Header	3	data length, fixed
5	Data	0, 1, 2, 3	desired DIO channel #
6	Data	0, 1	0: channel is in input mode 1: channel is in output mode
7	Data	0, 1	0: channel status is low 1: channel status is high

For example, the 7-byte response sequence **1-2-0-3-0-0-0** indicates that DIO 0 is in input mode.

C Code Example

```

BOOL ReadSingleDIO(int port, int *mode, int *status)
{
    DIOPacketStruct packet;

    packet.header.command = 1;    // read single DIO command
    packet.header.version = 2;    // DIO protocol version
    packet.header.length = 1;     // data length
    packet.data[0] = (char)port;  // Number of the DIO
    send(SocketFD, (char *)&packet, sizeof(DIOHeaderStruct)+1, 0);
//Send TCP Packet
    // Process the returned data here.
    return TRUE;
}

```

Write Single DIO

Command

Byte #	Descriptor	Value	Description
1	Header	2	command number, fixed
2	Header	2	version, fixed
3	Header	(any)	this byte is only used in the module's response
4	Header	3	data length, fixed
5	Data	0,1,2,3	desired DIO channel number
6	Data	0, 1	0: set to input mode 1: set to output mode
7	Data	0, 1	this byte is ignored for input mode 0: set to low 1: set to high

For example, the 7-byte command sequence **2-2-0-3-0-0-0** requests that DIO 0 be set to digital input mode.

Response

Byte #	Descriptor	Value	Description
1	Header	2	command number, fixed
2	Header	2	version, fixed
3	Header	0, 1, 2, 3, 4, 5, 6, 0xFF	command status/error code (0 = okay)
4	Header	3	data length, fixed
5	Data	0, 1, 2, 3	desired DIO channel #
6	Data	0, 1	0: channel has been changed to input mode 1: channel has been changed to output mode
7	Data	0, 1	this byte is ignored for input mode 0: channel status has been changed to low 1: channel status has been changed to high

For example, the 7-byte response sequence **2-2-0-3-0-0-0** indicates that DIO 0 has been changed to input mode.

C Code Example:

```
void WriteSingleDIO(int port, int mode, int status)
{
    DIOPacketStruct packet;

    packet.header.command = 2;    // write single DIO command
    packet.header.version = 2;    // DIO protocol version
    packet.header.length = 3;     // data length
    packet.data[0] = (char)port;  // number of the DIO
    packet.data[1] = (char)mode;  // DIO mode
    packet.data[2] = (char)status; // DIO status;
    send(SocketFd, (char *)&packet, sizeof(DIOHeaderStruct)+3, 0);
//Send TCP packet
    //Process the returned data here
}
```

Read Multiple DIO

Command

Byte #	Descriptor	Value	Description
1	Header	5	command number, fixed
2	Header	2	version, fixed
3	Header	(any)	this byte is only used in the module's response
4	Header	2	data length, fixed
5	Data	0,1,2	starting DIO channel number
6	Data	1,2,3	ending DIO channel number

This command requests the status of a range of DIO channels, specified in bytes 5 and 6. For example, the 6-byte command sequence **5-2-0-2-0-2** requests the status of DIO channels 0 through 2.

Response

Byte #	Descriptor	Value	Description
1	Header	5	command number, fixed
2	Header	2	version, fixed
3	Header	0, 1, 2, 3, 4, 5, 6, 0xFF	command status/error code (0 = okay)
4	Header	4, 6, 8	data length, depends on the number of DIO channels requested
5	Data	0, 1	1st requested DIO channel 0: channel is in input mode 1: channel is in output mode
6	Data	0, 1	1st requested DIO channel 0: channel status is low 1: channel status is high
7	Data	0, 1	2nd requested DIO channel 0: channel is in input mode 1: channel is in output mode

Byte #	Descriptor	Value	Description
8	Data	0, 1	2nd requested DIO channel 0: channel status is low 1: channel status is high
9	Data	0, 1	3rd requested DIO channel, optional 0: channel is in input mode 1: channel is in output mode
10	Data	0, 1	3rd requested DIO channel, optional 0: channel status is low 1: channel status is high
11	Data	0, 1	4th requested DIO channel, optional 0: channel is in input mode 1: channel is in output mode
12	Data	0, 1	4th requested DIO channel, optional 0: channel status is low 1: channel status is high

For example, the 10-byte response **5-2-0-6-0-0-1-1-0-1** indicates that DIO 0 is in input mode and “low” status, DIO 1 is in output mode and “high” status, and DIO 2 is in input mode and “high” status.

C Code Example:

```

BOOL ReadMultipleDIO(int start, int end, int *mode, int *status)
{
    DIOPacketStruct packet;

    packet.header.command = 5; // Read Multiple DIO Commands
    packet.header.version = 2; // DIO protocol command version
    packet.header.length = 2; // data length
    packet.data[0] = start; // start of the DIO number
    packet.data[1] = end; // end of the DIO number
    send(SocketFd, (char *)&packet, sizeof(DIOHeaderStruct)+2, 0);
//Send TCP packet
//Process the returned data here
return TRUE;
}

```

Write Multiple DIO

Command

Byte #	Descriptor	Value	Description
1	Header	6	command number, fixed
2	Header	2	version, fixed
3	Header	(any)	this byte is only used in the module's response
4	Header	6, 8, 10	data length, depends on the number of channels being written (6 bytes for 2 channels, 8 bytes for 3 channels, 10 bytes for 4 channels)
5	Data	0,1,2	starting DIO channel number
6	Data	1,2,3	ending DIO channel number

Byte #	Descriptor	Value	Description
7	Data	0,1	1st DIO channel to be written 0: set to input mode 1: set to output mode
8	Data	0,1	1st DIO channel to be written 0: set to low 1: set to high
9	Data	0,1	2nd DIO channel to be written 0: set to input mode 1: set to output mode
10	Data	0,1	2nd DIO channel to be written 0: set to low 1: set to high
11	Data	0,1	3rd DIO channel to be written, optional 0: set to input mode 1: set to output mode
12	Data	0,1	3rd DIO channel to be written, optional 0: set to low 1: set to high
13	Data	0,1	4th DIO channel to be written, optional 0: set to input mode 1: set to output mode
14	Data	0,1	4th DIO channel to be written, optional 0: set to low 1: set to high

This command writes the status of a range of DIO channels, specified in bytes 5 and 6. The length of the command depends on the number of channels to be written. For example, the 10-byte command **6-2-0-6-0-1-0-0-1-1** requests DIO 0 be set to digital input mode and “low” status and DIO 1 be set to digital output mode and “high” status. If you wanted to include a change of DIO 2 to digital output mode and “low” status, the 12-byte command sequence would be **6-2-0-8-0-2-0-0-1-1-1-0**.

Response

Byte #	Descriptor	Value	Description
1	Header	6	command number, fixed
2	Header	2	version, fixed
3	Header	0, 1, 2, 3, 4, 5, 6, 0xFF	command status/error code (0 = okay)
4	Header	4, 6, 8	data length, depends on the number of DIO channels requested
5	Data	0, 1	1st requested DIO channel 0: channel has been changed to input mode 1: channel has been changed to output mode
6	Data	0, 1	1st requested DIO channel 0: channel status has been changed to low 1: channel status has been changed to high

Byte #	Descriptor	Value	Description
7	Data	0, 1	2nd requested DIO channel 0: channel has been changed to input mode 1: channel has been changed to output mode
8	Data	0, 1	2nd requested DIO channel 0: channel status has been changed to low 1: channel status has been changed to high
9	Data	0, 1	3rd requested DIO channel, optional 0: channel has been changed to input mode 1: channel has been changed to output mode
10	Data	0, 1	3rd requested DIO channel, optional 0: channel status has been changed to low 1: channel status has been changed to high
11	Data	0, 1	4th requested DIO channel, optional 0: channel has been changed to input mode 1: channel has been changed to output mode
12	Data	0, 1	4th requested DIO channel, optional 0: channel status has been changed to low 1: channel status has been changed to high

For example, the 8-byte response **6-2-0-4-0-0-1-1** indicates that DIO 0 has been changed to input mode and “low” status and DIO 1 has been changed to output mode and “high” status.

C Code Example:

```
void WriteMultipleDIO(int start, int end, int* mode, int* status)
{
    DIOPacketStruct packet;

    packet.header.command = 6; // Write Multiple DIO Command Codes
    packet.header.version = 2; // DIO protocol version
    packet.header.length = (end-start+1)*2+2; // data length
    packet.data[0] = start; // start DIO number
    packet.data[1] = end; // end DIO number
    int i, len;
    for ( i=0; i<(end-start+1);i++ ) {
        packet.data[i+2] = mode[i];
        packet.data[i+3] = status[i];
    }
    send(SocketFd, (char*)&packet, (end-start+1)*2+2+sizeof(DIOHeaderStruct), 0);
    //Send TCP packet
    //Process the returned data here
}
```

E

SNMP Agent with MIB II & RS-232 Like Group

NE-4100 Series modules have built-in SNMP (Simple Network Management Protocol) agent software. It supports SNMP Trap, RFC1317 RS-232 like group and RFC 1213 MIB-II. The following table lists the standard MIB-II groups, as well as the variable implementations for NE-4100 Series modules.

RFC1 213 MIB-II supported SNMP variables:

System MIB	Interfaces MIB	IP MIB	ICMP MIB
SysDescr	itNumber	ipForwarding	IcmpInMsgs
SysObjectID	ifIndex	ipDefaultTTL	IcmpInErrors
SysUpTime	ifDescr	ipInreceives	IcmpInDestUnreachs
SysContact	ifType	ipInHdrErrors	IcmpInTimeExcds
SysName	ifMtu	ipInAddrErrors	IcmpInParmProbs
SysLocation	ifSpeed	ipForwDatagrams	IcmpInSrcQuenchs
SysServices	ifPhysAddress	ipInUnknownProtos	IcmpInRedirects
	ifAdminStatus	ipInDiscards	IcmpInEchos
	ifOperStatus	ipInDelivers	IcmpInEchoReps
	ifLastChange	ipOutRequests	IcmpInTimestamps
	ifInOctets	ipOutDiscards	IcmpTimestampReps
	ifInUcastPkts	ipOutNoRoutes	IcmpInAddrMasks
	ifInNUcastPkts	ipReasmTimeout	IcmpOutMsgs
	ifInDiscards	ipReasmReqds	IcmpOutErrors
	ifInErrors	ipReasmOKs	IcmpOutDestUnreachs
	ifInUnknownProtos	ipReasmFails	IcmpOutTimeExcds
	ifOutOctets	ipFragOKs	IcmpOutParmProbs
	ifOutUcastPkts	ipFragFails	IcmpOutSrcQuenchs
	ifOutNUcastPkts	ipFragCreates	IcmpOutRedirects
	ifOutDiscards	ipAdEntAddr	IcmpOutEchos
	ifOutErrors	ipAdEntIfIndex	IcmpOutEchoReps
	ifOutQLen	ipAdEntNetMask	IcmpOutTimestamps
	ifSpecific	ipAdEntBcastAddr	IcmpOutTimestampReps
		ipAdEntReasmMaxSize	IcmpOutAddrMasks

System MIB	Interfaces MIB	IP MIB	ICMP MIB
		IpNetToMediaIfIndex	IcmpOutAddrMaskReps
		IpNetToMediaPhysAddress	
		IpNetToMediaNetAddress	
		IpNetToMediaType	
		IpRoutingDiscards	

UDP MIB	TCP MIB	SNMP MIB
UdpInDatagrams	tcpRtoAlgorithm	snmpInPkts
UdpNoPorts	tcpRtoMin	snmpOutPkts
UdpInErrors	tcpRtoMax	snmpInBadVersions
UdpOutDatagrams	tcpMaxConn	snmpInBadCommunityNames
UdpLocalAddress	tcpActiveOpens	snmpInASNParseErrs
UdpLocalPort	tcpPassiveOpens	snmpInTooBigs
	tcpAttemptFails	snmpInNoSuchNames
Address Translation MIB	tcpEstabResets	snmpInBadValues
AtIfIndex	tcpCurrEstab	snmpInReadOnlys
AtPhysAddress	tcpInSegs	snmpInGenErrs
AtNetAddress	tcpOutSegs	snmpInTotalReqVars